

SUPERSUITE

OPERATING ROOM DIFFUSER SYSTEM WITH INTEGRATED LED LIGHTING EXAMPLE SYSTEM FOR A HYBRID OR/IMAGING SUITE

FEATURES:

- LAMINAR FLOW DIFFUSER ARRAY WITH INTEGRATED HIGH-PERFORMANCE LED LIGHTS INSIDE EACH INDIVIDUAL MODULE
- FULLY CUSTOMIZABLE TO MATCH THE DEMANDING AND OFTEN CROWDED MODERN HOSPITAL AND CLEANROOM CEILING LAYOUTS
- OPTIONAL PERIMETER APEX WELDED CEILING GRID SUPPORTS ACCESS PANELS AND FLUSH-MOUNT PANELS FOR EQUIPMENT BOOM INTEGRATION
- UL 1598 CERTIFIED, AIR-HANDLING LUMINAIRE

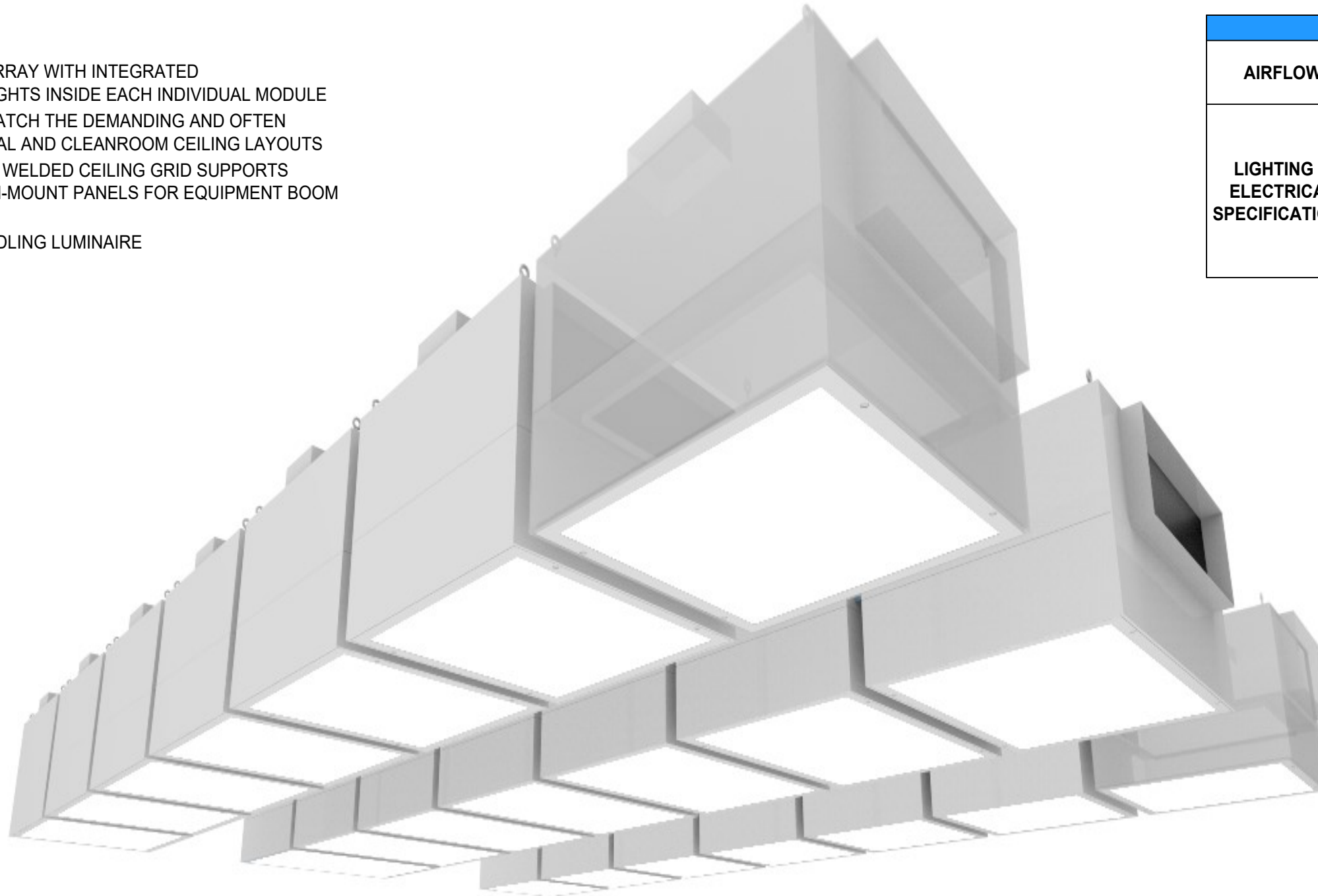

EXAMPLE SYSTEM		
AIRFLOW	2500	CFM
	20	ACH
LIGHTING & ELECTRICAL SPECIFICATIONS	5000K	COLOUR TEMPERATURE
	95	CRI
	100% TO 1%	DIMMING
	0-10V	
	277	INCOMING VOLTAGE

SUPERSUITE
by **PRICE**

Project:

274978

Revision: B

08-01-2023



SUPERSUITE ^{360°}

OPERATING ROOM DIFFUSER SYSTEM WITH INTEGRATED LED LIGHTING 3D INTERACTIVE MODEL - HYBRID OR/IMAGING SUITE

ORDER OF INSTALLATION
(CLICK BUTTONS TO TOGGLE VIEWS)

CEILING LEVEL SUPPORT STRUT

SUPERSUITE
(View A)

PLENUM MANIFOLD
(View A)

PLENUM MANIFOLD
(View B)

SUPERSUITE
(View B)

SUPERSUITE
(View C)

APEX CEILING GRID
(View A)

APEX CEILING GRID
(View B)

APEX-CP-SC CEILING PANELS

U-CHANNELS

PERIMETER HALF TEE

MEDICAL EQUIPMENT SUPPORT RAILS
(by Others)

CLOSURE STRIP

FINAL INSTALLATION

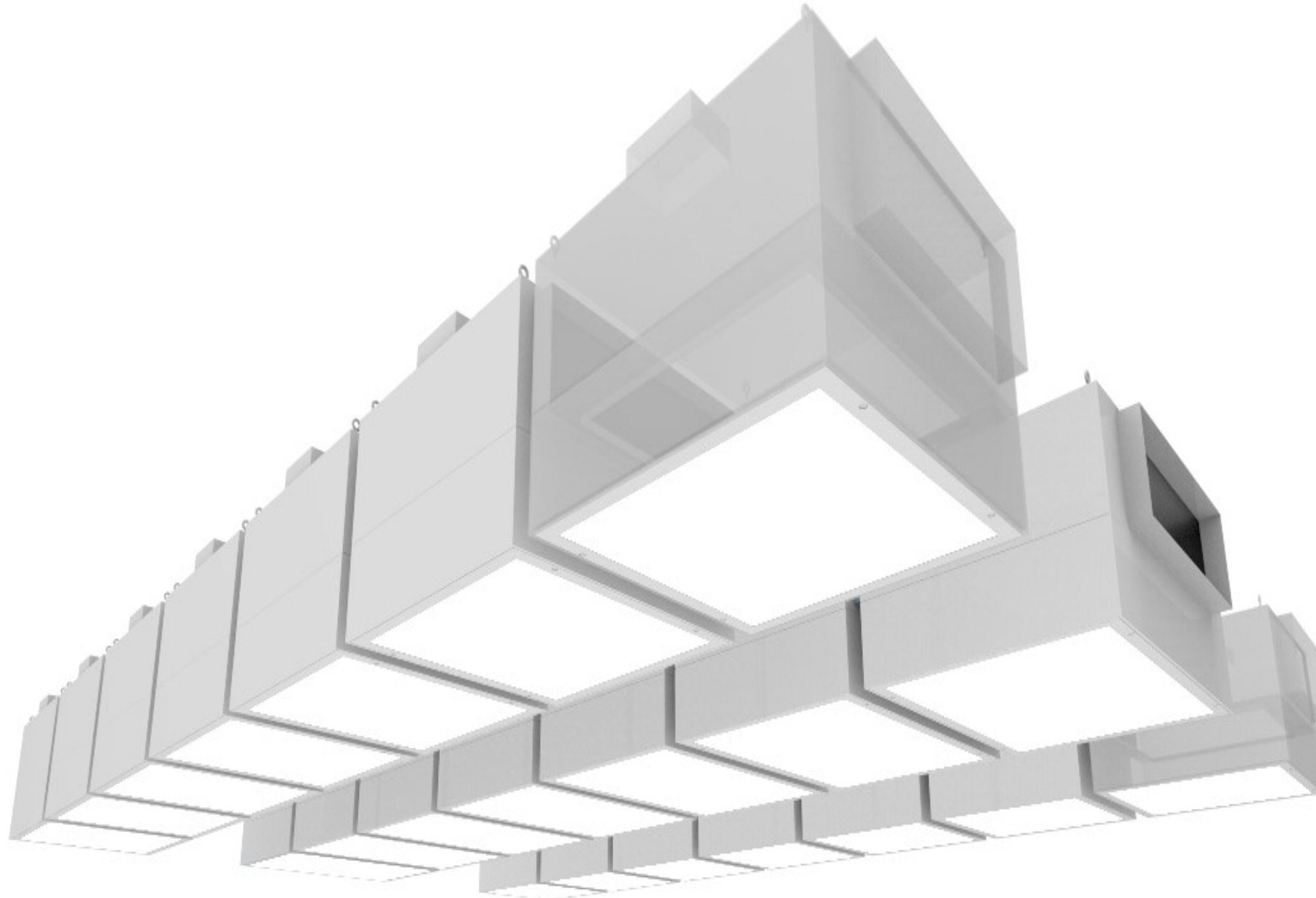

STRUCTURAL COMPONENTS
(CLICK BUTTONS TO TOGGLE VIEWS)

KEYSTONE SUPPLIED COMPONENTS

CEILING LEVEL SUPPORT STRUT &
MEDICAL EQUIPMENT SUPPORT RAILS
(by Others)

SECONDARY SUPPORT STRUT
(by Others)

VERTICAL & ANGULAR SUPPORT STRUT
(by Others)

BUILDING STRUCTURE
(by Others)

ROOMSIDE VIEW

ROOMSIDE VIEW WITH RCP
(View A)

ROOMSIDE VIEW WITH RCP
(View B)

- USE THE SCROLL WHEEL TO ZOOM
- HOLD DOWN THE LEFT MOUSE BUTTON TO ROTATE
- HOLD DOWN CTRL AND LEFT MOUSE BUTTON TO MOVE

BOOM SUPPORT PLATE AND SUPPORT TO STRUCTURE ARE DESIGNED, PROVIDED, AND INSTALLED BY OTHERS

CLICK IMAGE TO
ACTIVATE 3D PDF

 REVIT



SUPERSUITE
by **PRICE**

Project:

274978

Revision: B

08-01-2023

SUPERSUITE

OPERATING ROOM DIFFUSER SYSTEM WITH INTEGRATED LED LIGHTING

REFLECTED CEILING PLAN - HYBRID OR/IMAGING SUITE

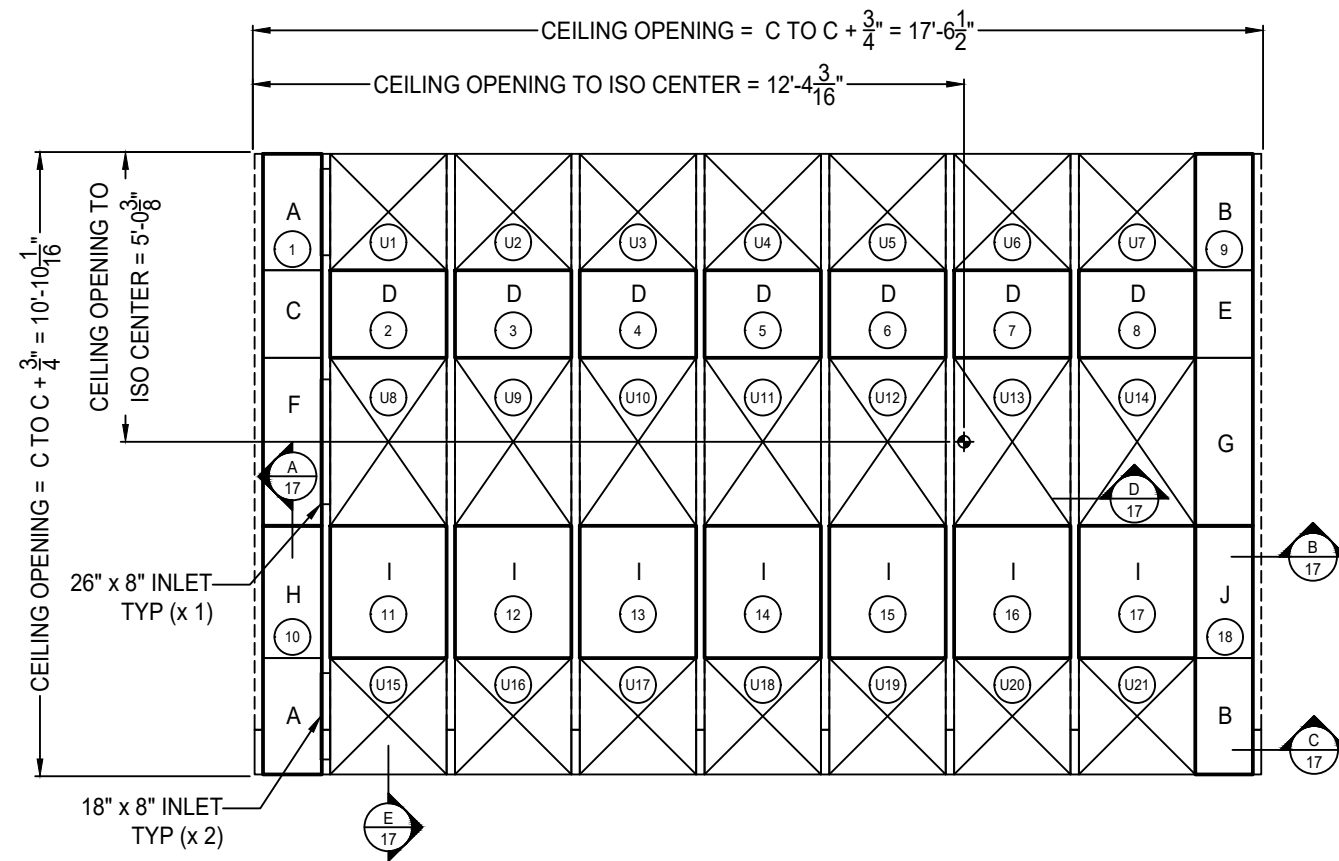

SSA AREA = 98 sq. ft. APEX AREA = 91 sq. ft.

U CHANNEL INTERNAL TRIM PIECE	APEX LOOSE HALF TEE PERIMETER TRIM PIECE	SSA - SUPERSUITE MODULES	SC - SOLID CORE ACCESS PANELS
1.75 x 9.312 (x9)	120" (x8)	24 x 24 (x 14) 24 x 35 (x 7)	A: 12.1 x 24.0 (x2) B: 11.9 x 24.0 (x2) C: 12.1 x 18.1 (x1) D: 18.1 x 24.0 (x7) E: 11.9 x 18.1 (x1) F: 12.1 x 34.6 (x1) G: 11.9 x 34.6 (x1) H: 12.1 x 27.3 (x1) I: 24.0 x 27.3 (x7) J: 11.9 x 27.3 (x1)

ASHRAE 170-2021 TABLE COVERAGE VERIFICATION - HYBRID OR/IMAGING SUITE

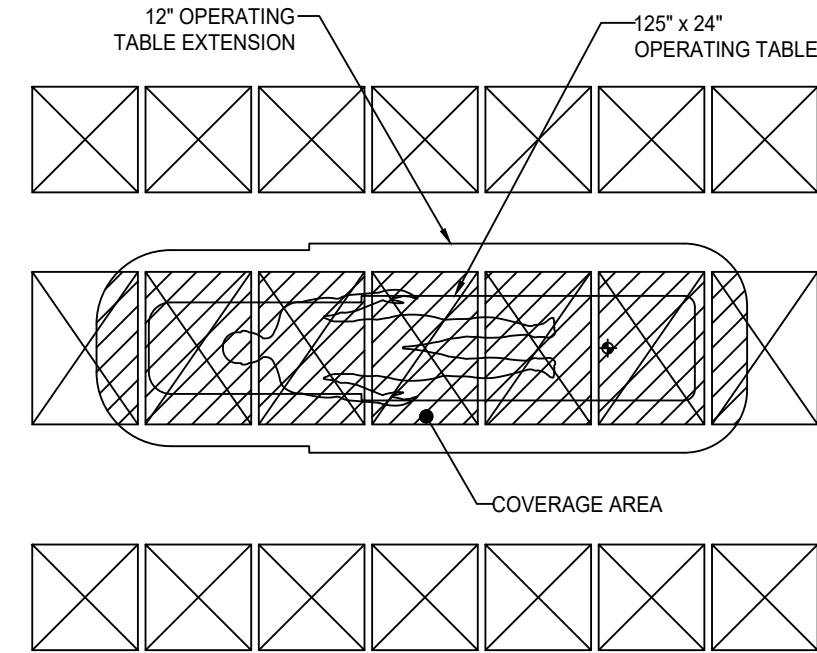

THIS LAYOUT COMPLIES WITH ASHRAE 170-2021 7.4.1.b.

ASHRAE 170-2021 7.4.1.a. COMPLIANCE AIRFLOW RANGE	ASHRAE 170-2021 7.4.1.b. COMPLIANCE
2500 - 3400 CFM BASED ON 98 SQFT	29% OF THE 12" OPERATING TABLE EXTENSION USED FOR NON DIFFUSER USES

ASHRAE 170-2021

7.4.1.a. - THE AIRFLOW SHALL BE UNIDIRECTIONAL, DOWNWARDS, AND THE **AVERAGE VELOCITY OF THE DIFFUSERS SHALL BE 25 TO 35 CFM/SQFT** (127 TO 178 L/S/SQM). THE DIFFUSERS SHALL BE CONCENTRATED TO PROVIDE AN AIRFLOW PATTERN OVER THE PATIENT AND SURGICAL TEAM.

7.4.1.b. - THE COVERAGE AREA OF THE PRIMARY SUPPLY DIFFUSER ARRAY SHALL EXTEND A MINIMUM OF 12 IN. (305 mm) BEYOND THE FOOTPRINT OF THE SURGICAL TABLE ON EACH SIDE. WITHIN THE PORTION OF THE PRIMARY SUPPLY DIFFUSER ARRAY THAT CONSISTS OF **AN AREA ENCOMPASSING 12 IN. (305mm) ON EACH SIDE OF THE FOOTPRINT OF THE SURGICAL TABLE, NO MORE THAN 30% OF THIS PORTION OF THE PRIMARY SUPPLY DIFFUSER ARRAY AREA SHALL BE USED FOR NON DIFFUSER USES** SUCH AS LIGHTS, GAS COLUMNS, EQUIPMENT BOOMS, ACCESS PANELS, SPRINKLERS, ETC.

SUPERSUITE
by price

Project:

274978

Revision: B

08-01-2023

- B12 STANDARD WHITE FINISH
- PANEL CUTOUTS FOR BOOMS DONE IN FIELD BY OTHERS
- THE CEILING IS FACTORY PREMANUFACTURED TO SIZES AND TOLERANCE $\pm 1/16$ "
- SITE ADJUSTMENTS TO PERIMETER SOFFITS AND/OR DRYWALL MAY BE REQUIRED AND ARE THE RESPONSIBILITY OF THE INSTALLER
- ASHRAE 170 VERIFICATION IS SHOWN TO ASSIST IN PROJECT COORDINATION. FINAL ASHRAE 170 COMPLIANCE, AS WELL AS COMPLIANCE WITH ALL APPLICABLE LOCAL CODES AND REQUIREMENTS REMAINS THE RESPONSIBILITY OF THE EOR OR INSTALLER ON THE PROJECT

SUPERSUITE

OPERATING ROOM DIFFUSER SYSTEM WITH INTEGRATED LED LIGHTING PHOTOMETRIC ANALYSIS - HYBRID OR/IMAGING SUITE

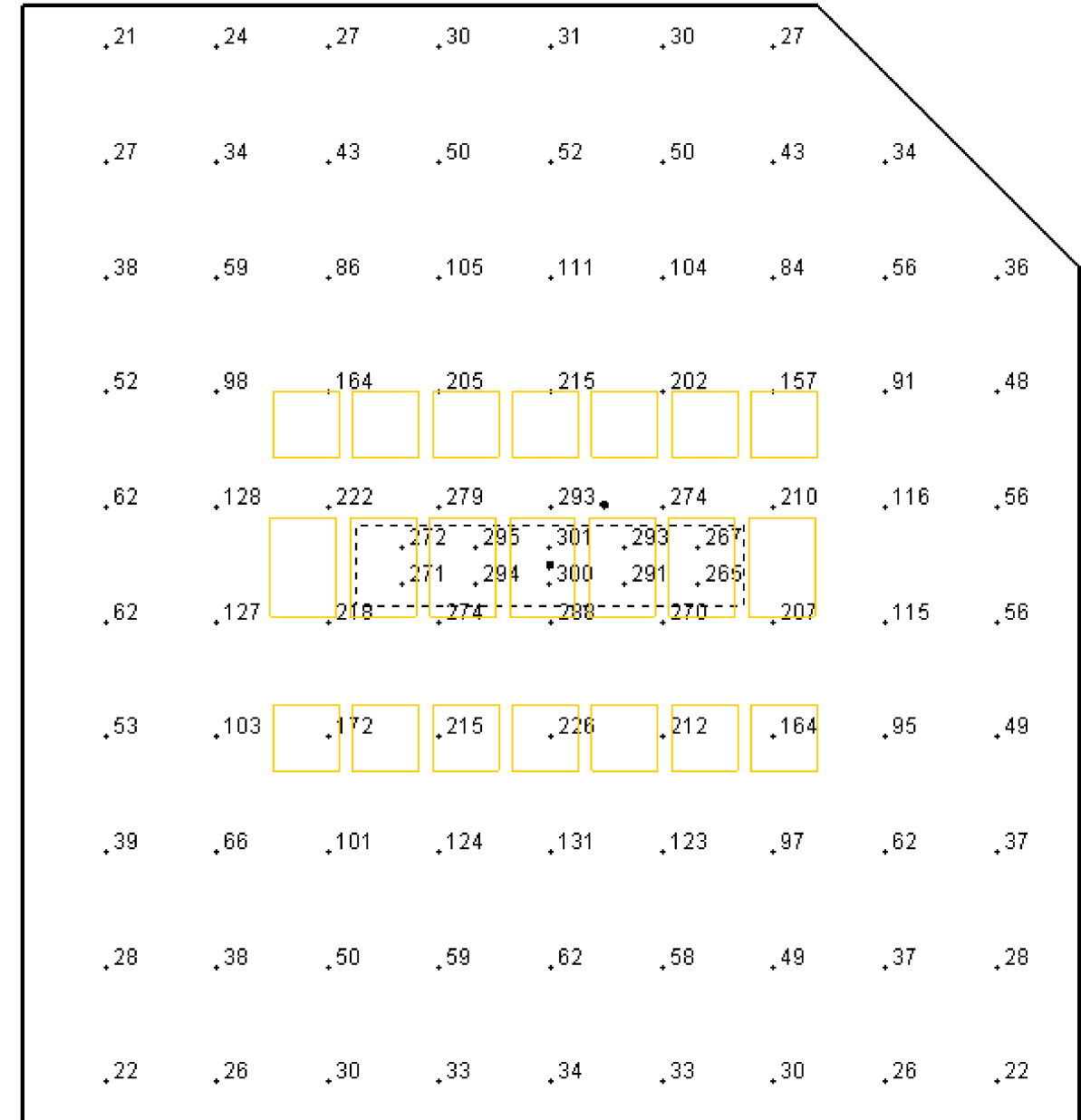
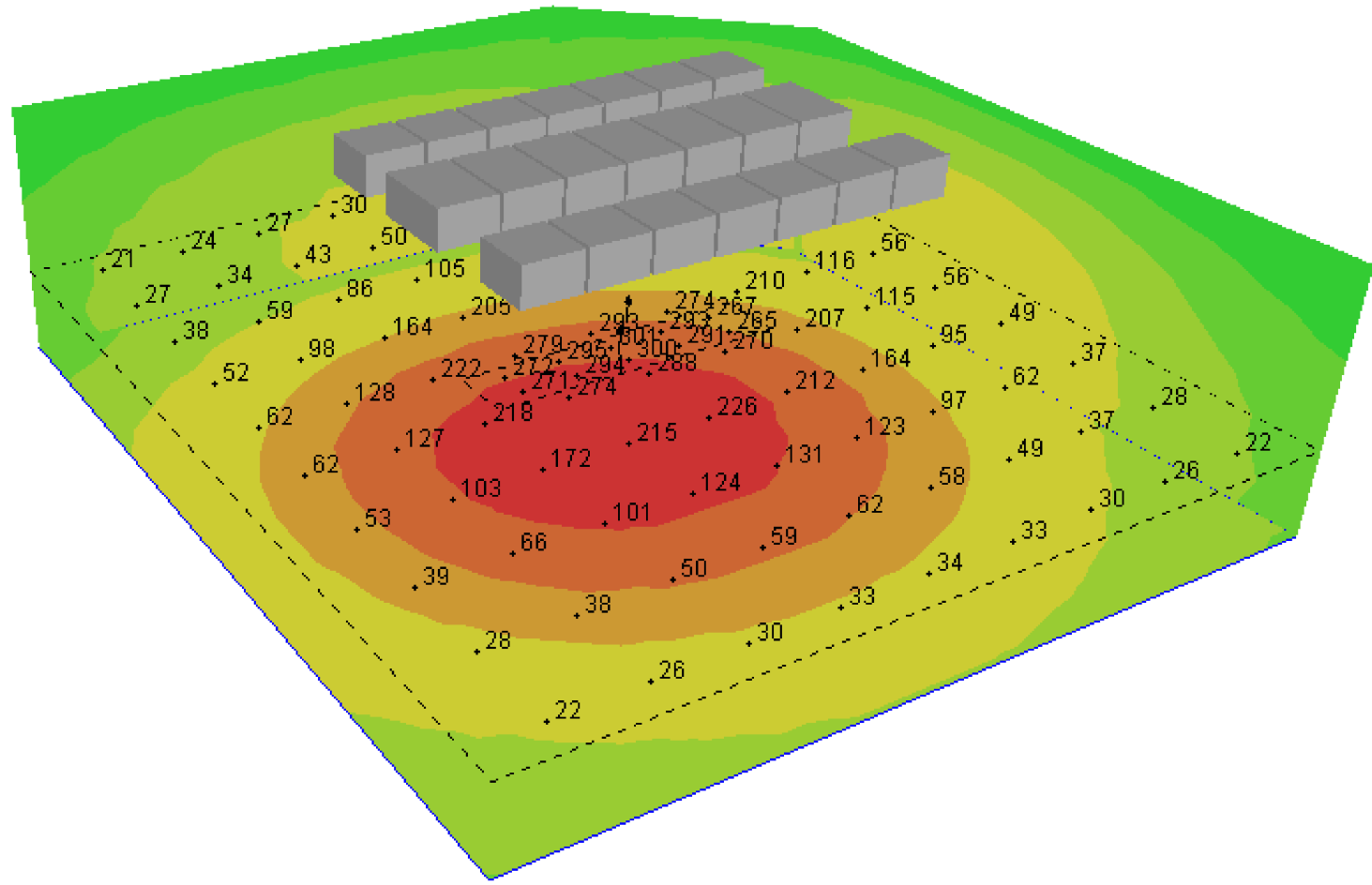

OPERATING TABLE		OPERATING AREA	
MAXIMUM	301 fc	MAXIMUM	293 fc
AVERAGE	285 fc	AVERAGE	97 fc

LUMINAIRE HEIGHT: 9 FT
CALCULATION ZONE: 3 FT

SUPERSUITE

by **price**

Project:

274978

Revision: B

08-01-2023

- PHOTOMETRIC ANALYSIS BASED ON A 3' CALCULATION ZONE, 833 ROOM SQFT & 9' CEILING HEIGHT.
- ANSII/IES RP-29-16 RECOMMENDS 3000 LUX (279 FC) AT THE OPERATING TABLE
- THE CALCULATED VALUES REFLECT ADDITIONAL SPACE LIGHTING BY OTHERS.
- LIGHTING ANALYSIS HAS BEEN PERFORMED USING THIRD PARTY LAB TESTED .IES FILES.
- THIS LAYOUT REFLECTS TWO ROWS OF 5000K, 90+ CRI LEDS PER MODULE. A THIRD ROW, HIGH OUTPUT OPTION IS AVAILABLE.
- LIGHTING CALCULATIONS ARE ESTIMATED USING BEST PRACTICE AND MAY DIFFER SLIGHTLY FROM ACTUAL FIELD CONDITIONS.

SUPERSUITE

OPERATING ROOM DIFFUSER SYSTEM WITH INTEGRATED LED LIGHTING

- SRDC SUPER REMOTE DRIVER CABINETS - SINGLE DIMMING ZONE (100 TO 1% DIMMING) - HYBRID OR/IMAGING SUITE PRECISION DIMMING OPTION

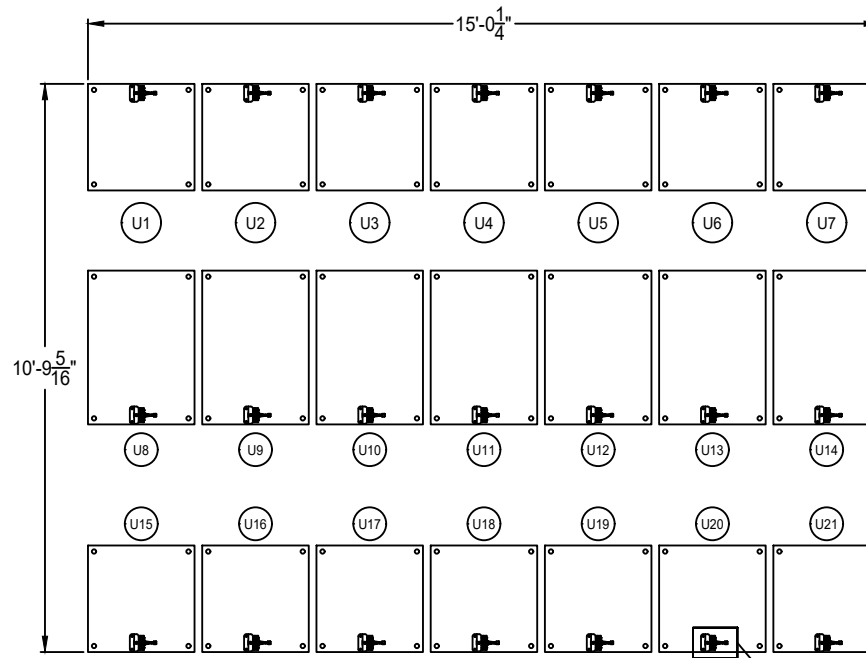
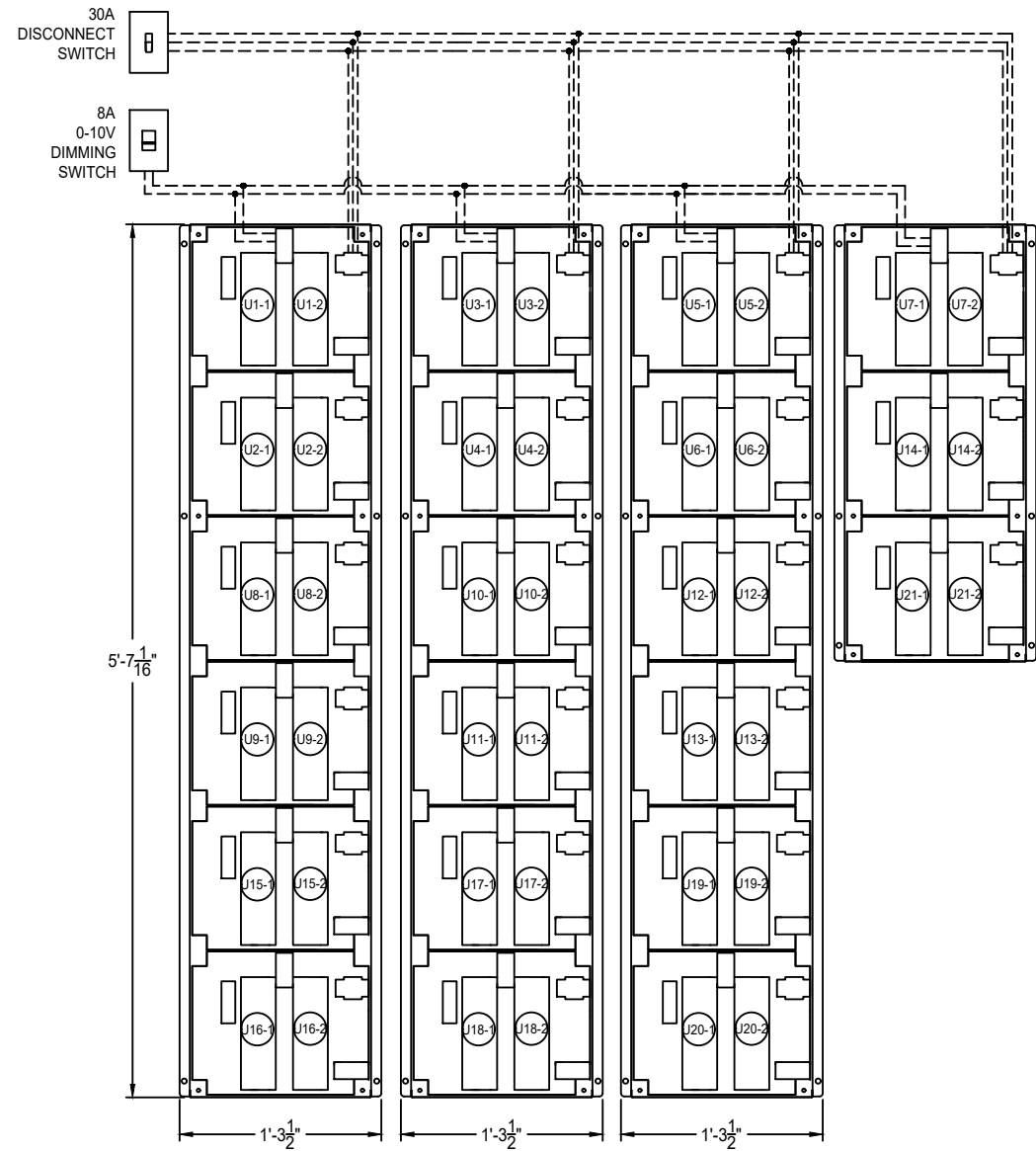

CABINET 1 - 1 OF 4 - CONTROLS 6 MODULES WITH 12 DRIVERS			
DRIVER TAG	LED WATTAGE	DRIVER TAG	LED WATTAGE
U1-1	56	U1-2	56
U2-1	56	U2-2	56
U8-1	72	U8-2	72
U9-1	72	U9-2	72
U15-1	56	U15-2	56
U16-1	56	U16-2	56
TOTAL WATTAGE:	AC CURRENT:		
736	4.8A/277VAC		

CABINET 2 - 2 OF 4 - CONTROLS 6 MODULES WITH 12 DRIVERS			
DRIVER TAG	LED WATTAGE	DRIVER TAG	LED WATTAGE
U3-1	56	U1-2	56
U4-1	56	U2-2	56
U10-1	72	U8-2	72
U11-1	72	U9-2	72
U17-1	56	U15-2	56
U18-1	56	U16-2	56
TOTAL WATTAGE:	AC CURRENT:		
736	4.8A/277VAC		

CABINET 3 - 3 OF 4 - CONTROLS 6 MODULES WITH 12 DRIVERS			
DRIVER TAG	LED WATTAGE	DRIVER TAG	LED WATTAGE
U5-1	56	U5-1	56
U6-1	56	U6-2	56
U12-1	72	U12-2	72
U13-1	72	U13-2	72
U19-1	56	U19-2	56
U20-1	56	U20-2	56
TOTAL WATTAGE:	AC CURRENT:		
736	4.8A/277VAC		

CABINET 4 - 4 OF 4 - CONTROLS 3 MODULES WITH 6 DRIVERS			
DRIVER TAG	LED WATTAGE	DRIVER TAG	LED WATTAGE
U7-1	56	U7-2	56
U14-1	72	U14-2	72
U21-1	56	U21-2	56
TOTAL WATTAGE:	AC CURRENT:		
368	2.4A/277VAC		



EACH STANDARD MODULE COMES WITH TWO ROWS OF LEDS THAT EACH REQUIRE ONE (+ & -) LOW VOLTAGE FIELD CONNECTION AND ARE NOTED BY A "UX-X" LABEL. A THIRD ROW, HIGH OUTPUT OPTION IS AVAILABLE IF REQUIRED.

EACH STANDARD MODULE COMES WITH 2 ROWS OF LED LIGHTS AND EACH ROW OF LIGHTS IS NOTED BY A "UX-X" LABEL. THE "UX" CORRESPONDS TO AN INDIVIDUAL MODULE REFERENCED IN THE RCP AND THE "-1" AND "-2" CORRESPONDS TO THE ROW OF LEDS FOR THAT MODULE. EACH "UX-X" LABEL CORRESPONDS TO ONE (+ & -) LOW VOLTAGE WIRE TO BE FIELD CONNECTED TO SRDC DRIVER CABINET AS PER THE MATCHING LABELS. EACH 100W DRIVER CAN POWER 1 ROW OF LEDS (ONE HALF OF A MODULE) AND EACH 600W DRIVER CAN CONTROL 6 ROWS OF LEDS (3 MODULES)

EACH MODULE COMES WITH A TOP MOUNTED TERMINAL BLOCK ENCLOSURE (COVER NOT SHOWN) FOR LOW VOLTAGE FIELD CONNECTIONS. QUICK CONNECT FITTING IS SEALED THROUGH PLENUM AND ALL INTERNAL WIRING IS COMPLETED IN THE FACTORY. EACH ROW OF LEDS REQUIRES ONE (+&-) LOW VOLTAGE FIELD CONNECTIONS (TWO PER MODULE)

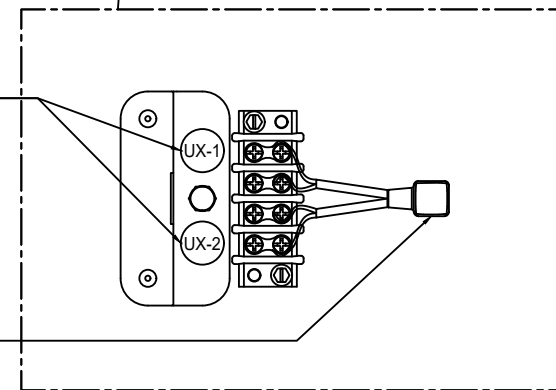

SUPERSUITE
by price

Project:

274978

Revision: B

08-01-2023

SUPERSUITE

OPERATING ROOM DIFFUSER SYSTEM WITH INTEGRATED LED LIGHTING

- SRDC SUPER REMOTE DRIVER CABINETS - SINGLE DIMMING ZONE (100 TO 10% DIMMING) - HYBRID OR/IMAGING SUITE COMPACT / SPACE SAVINGS OPTION

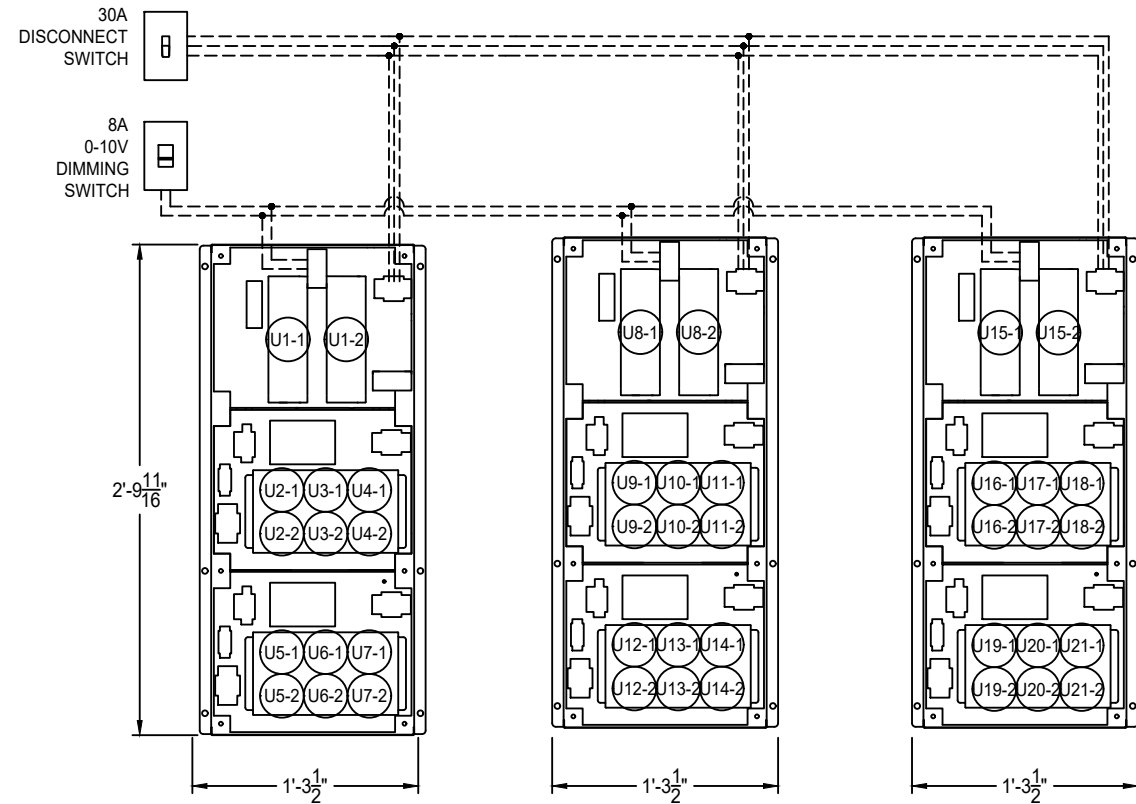

CABINET 1 OF 3 CONTROLS 7 MODULES WITH 4 DRIVERS. THE MAX AMP DRAW IS 6.8A @ 277V~.

CABINET 2 OF 3 CONTROLS 7 MODULES WITH 4 DRIVERS. THE MAX AMP DRAW IS 6.8A @ 277V~.

CABINET 3 OF 3 CONTROLS 7 MODULES WITH 4 DRIVERS. THE MAX AMP DRAW IS 6.8A @ 277V~.

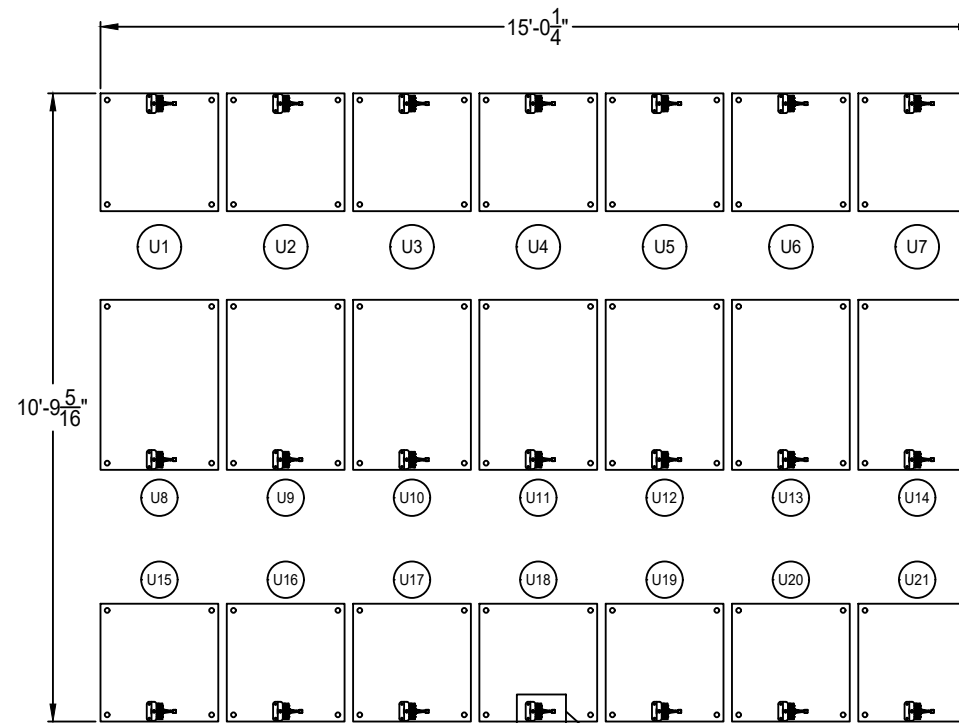

CABINET 1 - 1 OF 2 - CONTROLS 6 MODULES WITH 2 DRIVERS					
DRIVER TAG	LED WATTAGE	LED DRIVER LOADING (%)	DRIVER TAG	LED WATTAGE	LED DRIVER LOADING (%)
U1-1	56	58%	U1-2	56	58%
U2-1	56	56%	U5-1	56	56%
U2-2	56		U5-2	56	
U3-1	56		U6-1	56	
U3-2	56		U6-2	56	
U4-1	56		U7-1	56	
U4-2	56		U7-2	56	
TOTAL WATTAGE:		784	AC CURRENT:		6.8A/277VAC

CABINET 2 - 2 OF 3 - CONTROLS 7 MODULES WITH 4 DRIVERS					
DRIVER TAG	LED WATTAGE	LED DRIVER LOADING (%)	DRIVER TAG	LED WATTAGE	LED DRIVER LOADING (%)
U8-1	72	75%	U8-2	72	75%
U9-1	72	72%	U12-1	72	72%
U9-2	72		U12-2	72	
U10-1	72		U13-1	72	
U10-2	72		U13-2	72	
U11-1	72		U14-1	72	
U11-2	72		U14-2	72	
TOTAL WATTAGE:		1008	AC CURRENT:		6.8A/277VAC

CABINET 3 - 3 OF 3 - CONTROLS 7 MODULES WITH 4 DRIVERS					
DRIVER TAG	LED WATTAGE	LED DRIVER LOADING (%)	DRIVER TAG	LED WATTAGE	LED DRIVER LOADING (%)
U15-1	56	58%	U15-2	56	58%
U16-1	56	56%	U19-1	56	56%
U16-2	56		U19-2	56	
U17-1	56		U20-1	56	
U17-2	56		U20-2	56	
U18-1	56		U21-1	56	
U18-2	56		U21-2	56	
TOTAL WATTAGE:		784	AC CURRENT:		6.8A/277VAC



EACH STANDARD MODULE COMES WITH TWO ROWS OF LEDS THAT EACH REQUIRE ONE (+ & -) LOW VOLTAGE FIELD CONNECTION AND ARE NOTED BY A "UX-X" LABEL. A THIRD ROW, HIGH OUTPUT OPTION IS AVAILABLE IF REQUIRED.

EACH STANDARD MODULE COMES WITH 2 ROWS OF LED LIGHTS AND EACH ROW OF LIGHTS IS NOTED BY A "UX-X" LABEL. THE "UX" CORRESPONDS TO AN INDIVIDUAL MODULE REFERENCED IN THE RCP AND THE "-1" AND "-2" CORRESPONDS TO THE ROW OF LEDS FOR THAT MODULE. EACH "UX-X" LABEL CORRESPONDS TO ONE (+ & -) LOW VOLTAGE WIRE TO BE FIELD CONNECTED TO SRDC DRIVER CABINET AS PER THE MATCHING LABELS. EACH 100W DRIVER CAN POWER 1 ROW OF LEDS (ONE HALF OF A MODULE) AND EACH 600W DRIVER CAN CONTROL 6 ROWS OF LEDS (3 MODULES)

EACH MODULE COMES WITH A TOP MOUNTED TERMINAL BLOCK ENCLOSURE (COVER NOT SHOWN) FOR LOW VOLTAGE FIELD CONNECTIONS. QUICK CONNECT FITTING IS SEALED THROUGH PLENUM AND ALL INTERNAL WIRING IS COMPLETED IN THE FACTORY. EACH ROW OF LEDS REQUIRES ONE (+&-) LOW VOLTAGE FIELD CONNECTIONS (TWO PER MODULE)

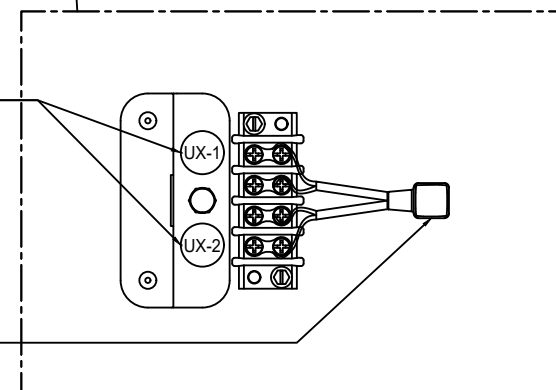

SUPERSUITE
by price

Project:

274978

Revision: B

08-01-2023

SUPERSUITE

OPERATING ROOM DIFFUSER SYSTEM WITH INTEGRATED LED LIGHTING SUPERSUITE SHIP SECTION BREAKDOWN & HANGING LOCATIONS - HYBRID OR/IMAGING SUITE

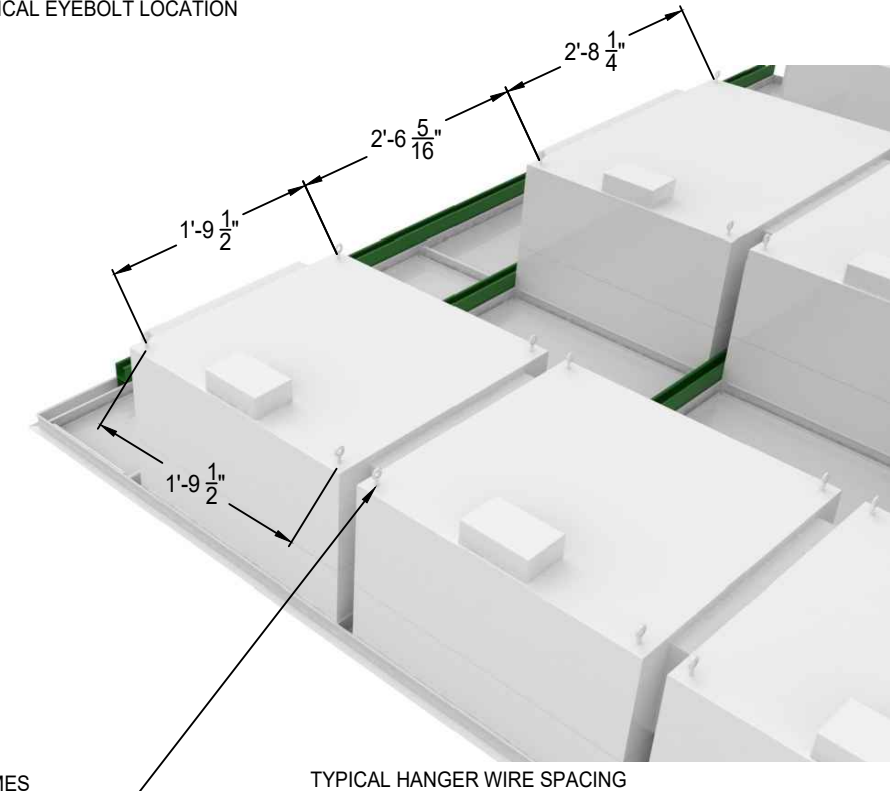
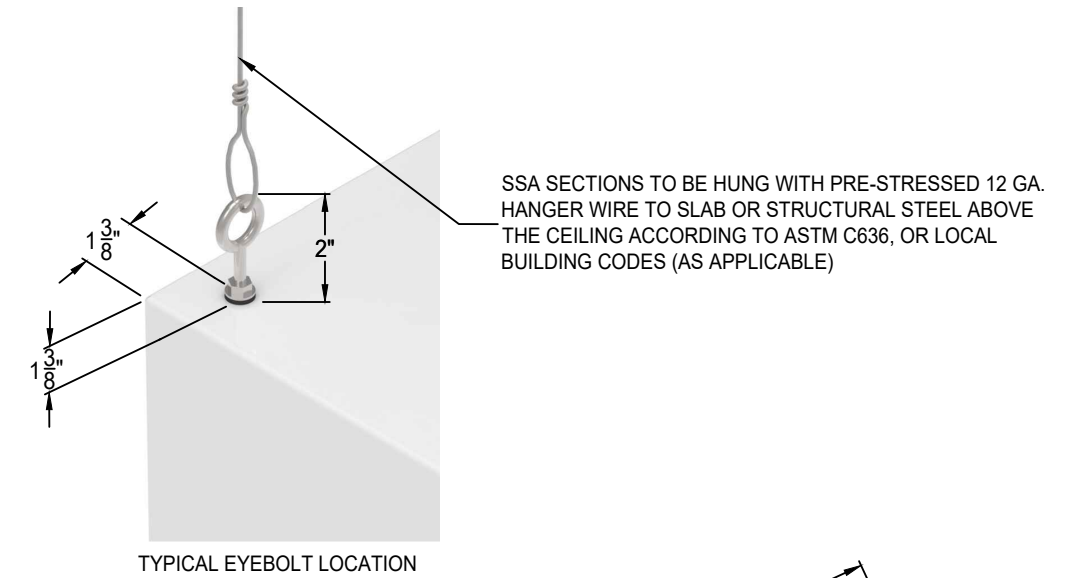
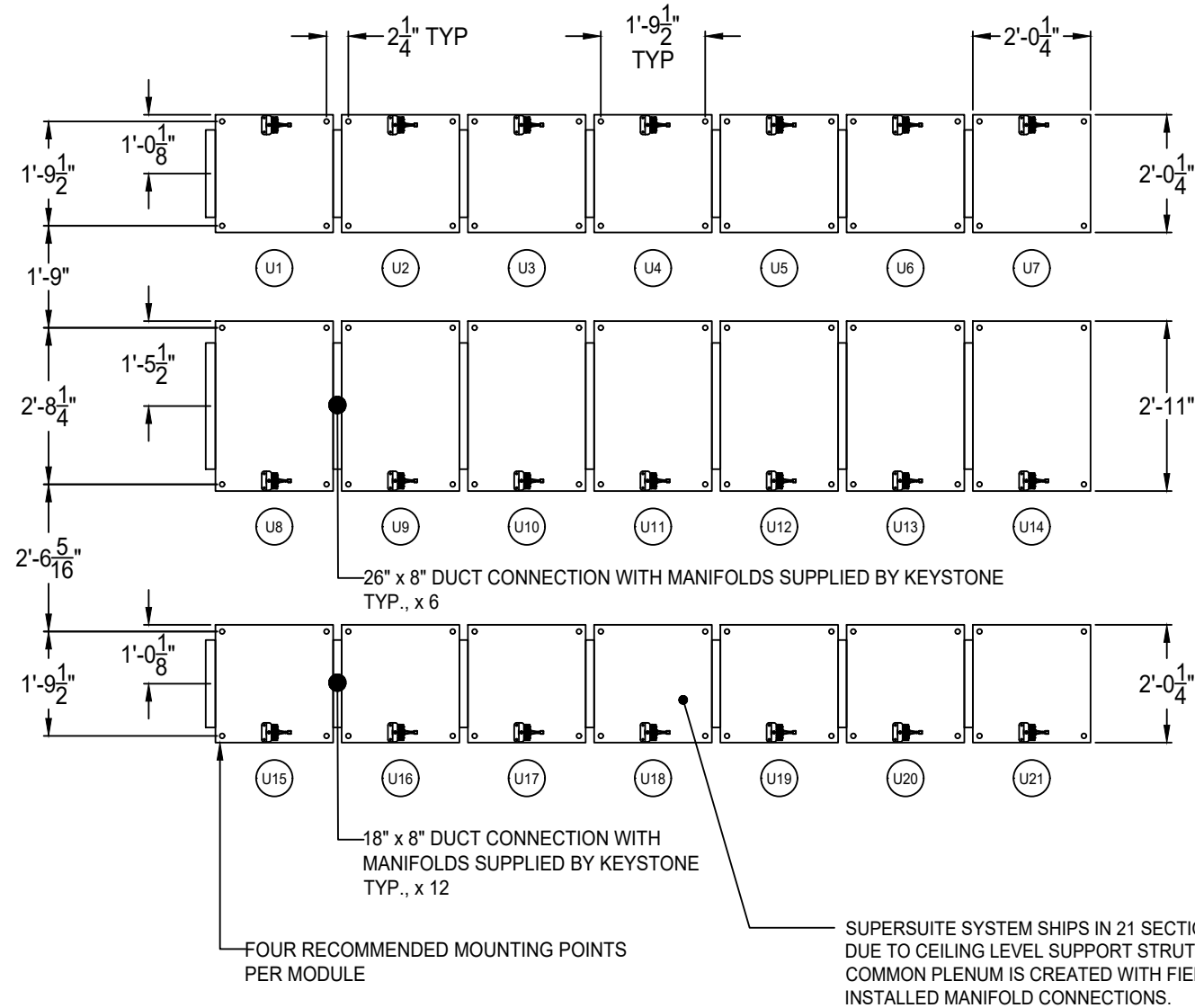

EACH SUPERSUITE MODULE COMES WITH 4 EYE BOLTS FOR HANGING. KEYSTONE RECOMMENDS HANGING EACH UNIT INDIVIDUALLY WITH THE FOUR RECOMMENDED MOUNTING POINTS PER MODULE

SUPERSUITE
by price

Project:

274978

Revision: B

08-01-2023

- SUPERSUITE SHIPS IN FACTORY WELDED SHIP SECTIONS TO BE FASTENED TOGETHER IN THE FIELD BY OTHERS
- MOUNTING LOCATIONS ARE SHOWN FOR REFERENCE ONLY. EXACT MOUNTING LOCATIONS TO BE DETERMINED BY THE EOR OR INSTALLER ON THE PROJECT AND MUST COMPLY WITH ALL APPLICABLE CODES AND STANDARDS.

SUPERSUITE

OPERATING ROOM DIFFUSER SYSTEM WITH INTEGRATED LED LIGHTING APEX SHIP SECTION BREAKDOWN & HANGING DETAILS - HYBRID OR/IMAGING SUITE

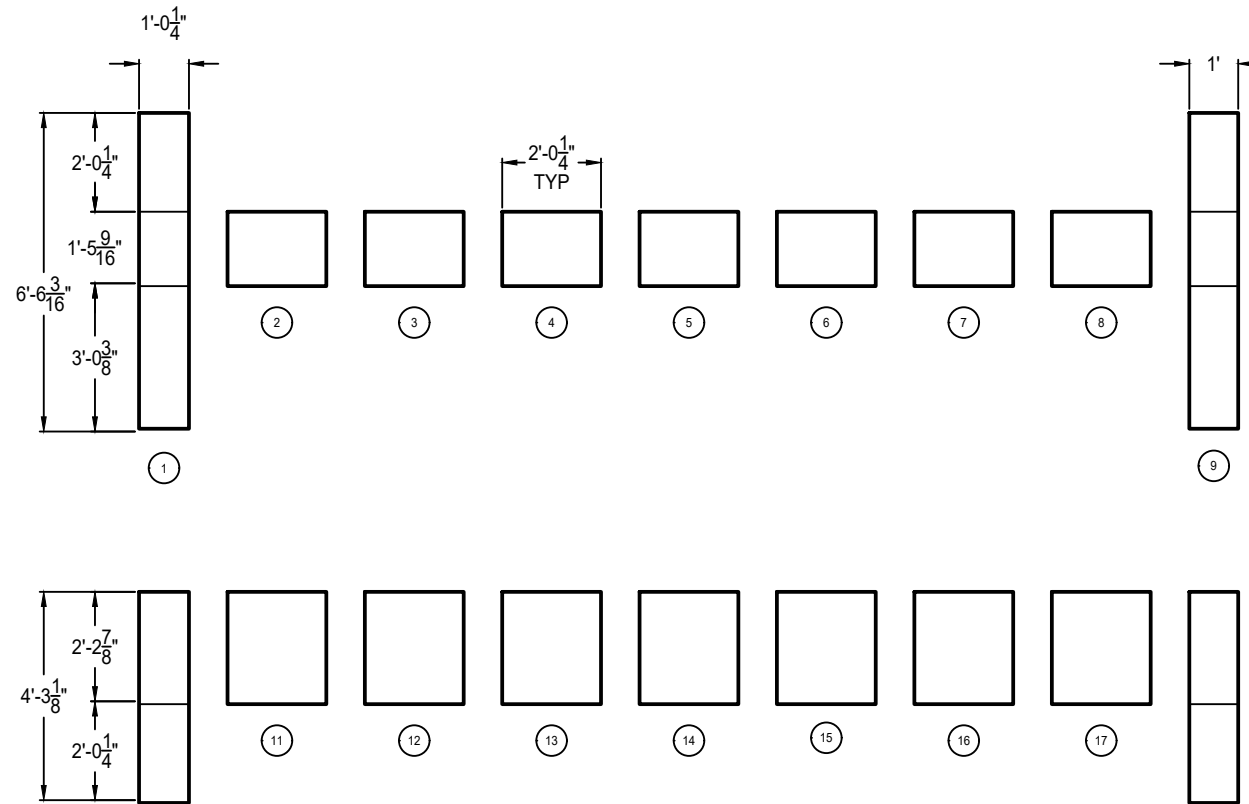
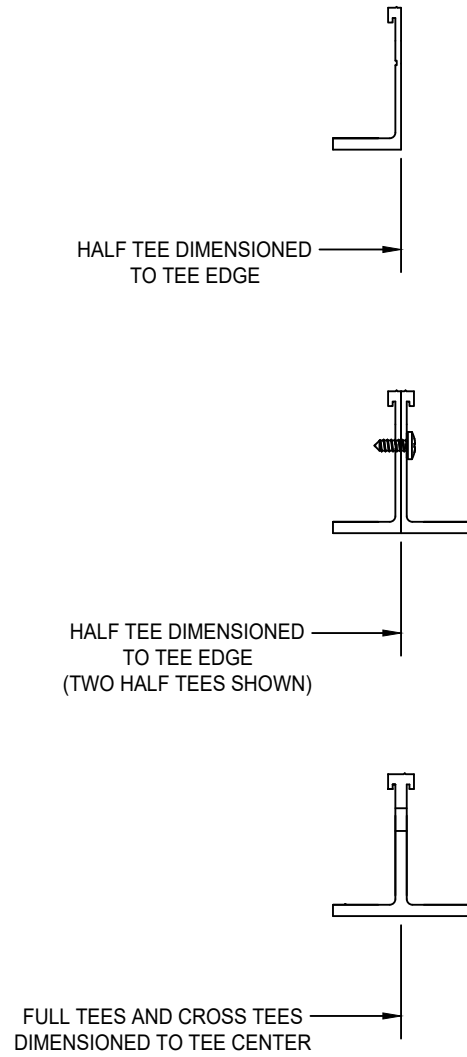

TYPICAL HANGER WIRE LOCATION

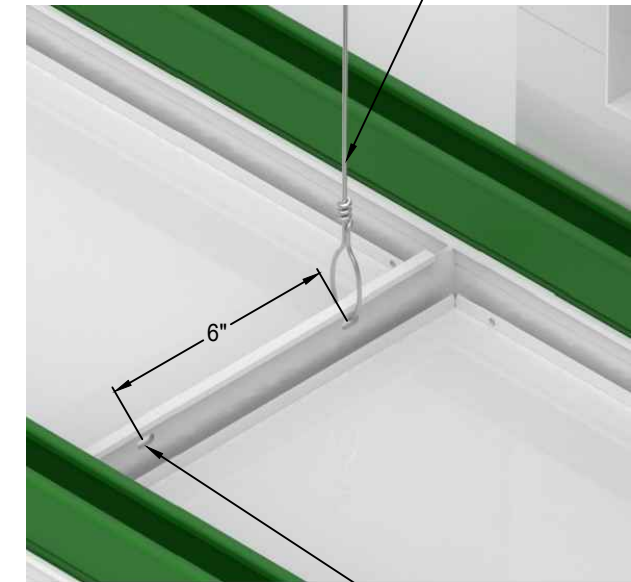

APEX SECTIONS TO BE HUNG WITH PRE-STRESSED 12 GA. HANGER WIRE TO SLAB OR STRUCTURAL STEEL ABOVE THE CEILING ACCORDING TO ASTM C636, OR LOCAL BUILDING CODES (AS APPLICABLE)

EACH APEX FULL TEE & CROSS TEE COME WITH PRE-PUNCHED SLOTS EVERY 6" PRICE RECOMMENDS HANGING SYSTEM EVERY ~4' AS REQUIRED

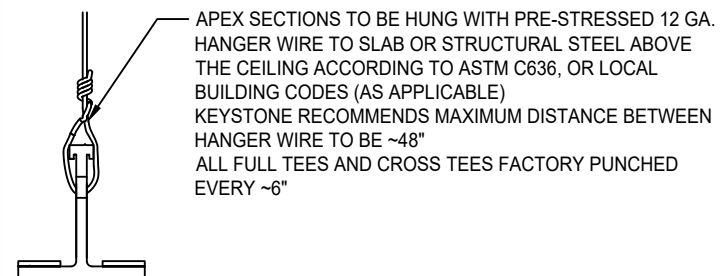
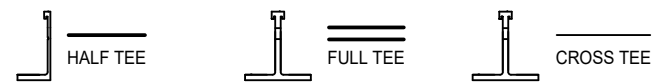

- THE APEX GRID IS SUPPLIED IN MULTIPLE FACTORY ASSEMBLED SECTIONS NO LARGER THAN 10'x4'
- THE CEILING IS FACTORY PRE-MANUFACTURED TO SIZES AND TOLERANCE +/- 1/16"

SUPERSUITE
by **PRICE**

Project:

274978

Revision: B

08-01-2023

SUPERSUITE

OPERATING ROOM DIFFUSER SYSTEM WITH INTEGRATED LED LIGHTING

CEILING LEVEL SUPPORT STRUT INTEGRATION DETAIL

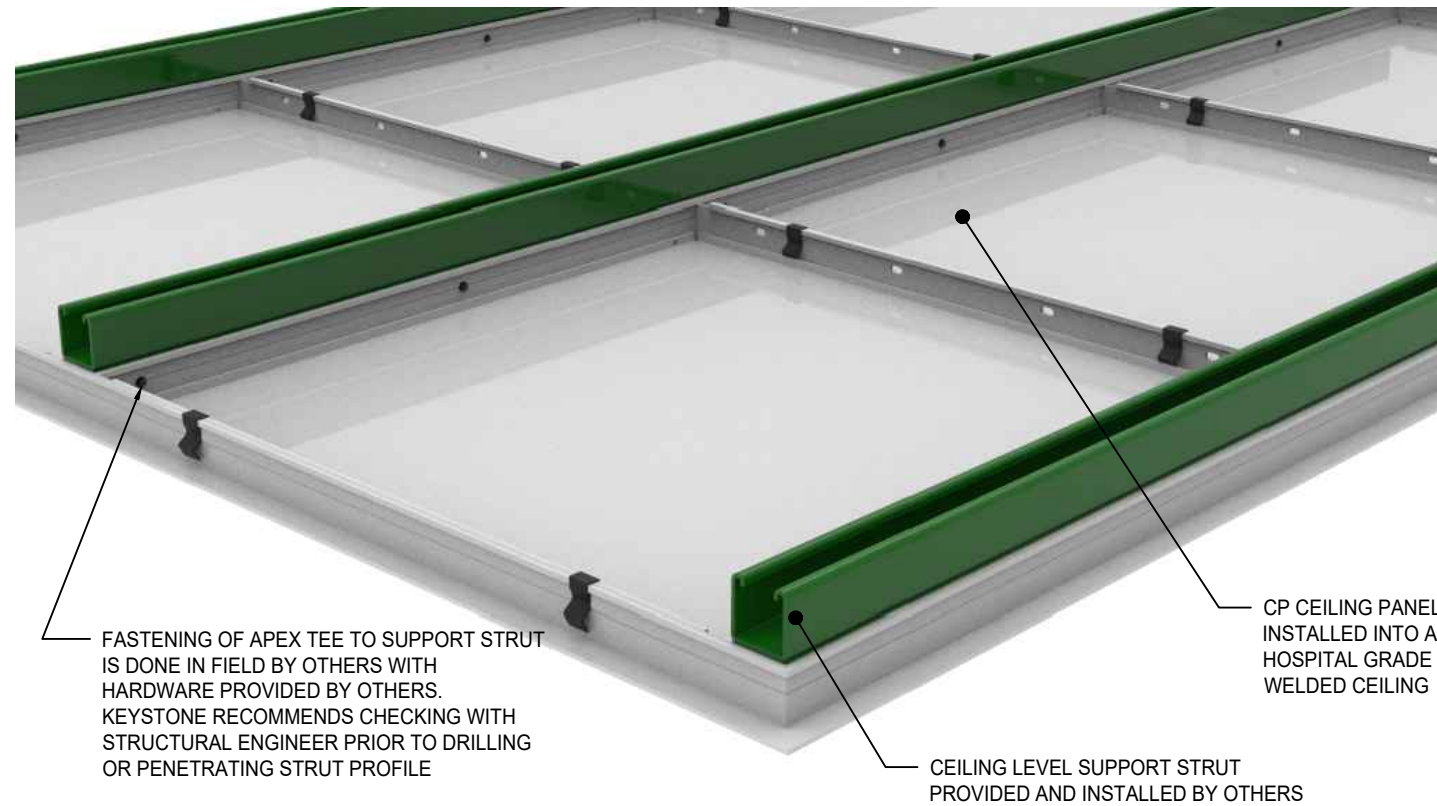

CEILING LEVEL SUPPORT STRUT LAYOUT - HYBRID OR/IMAGING SUITE

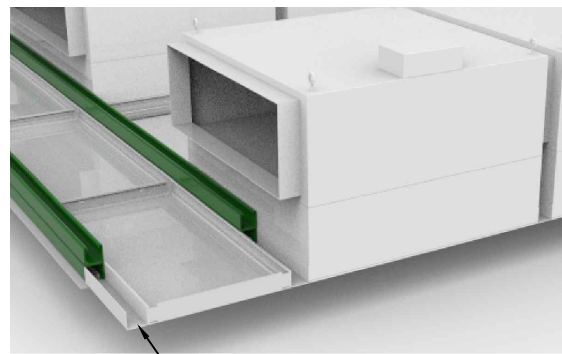
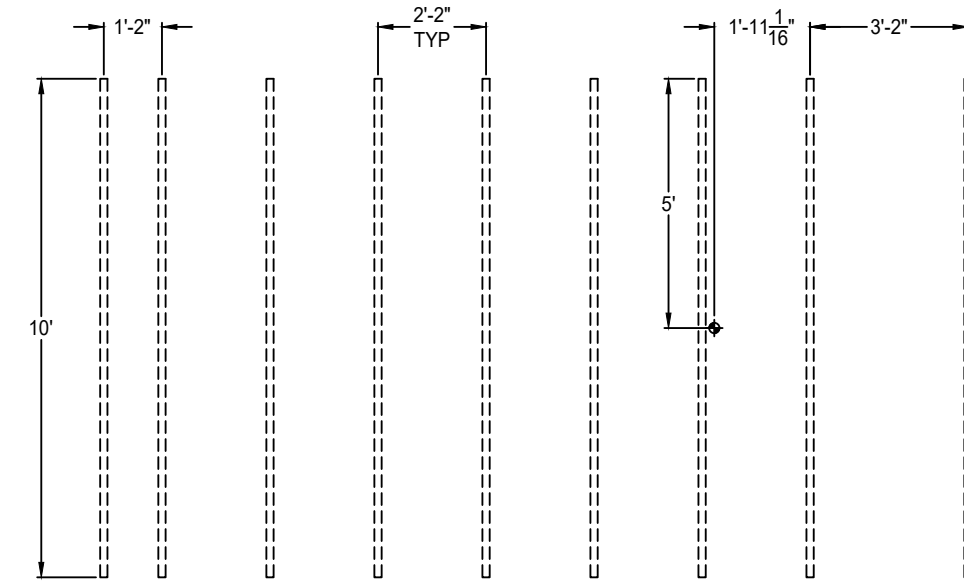

PRICE SUPPLIED U-CHANNEL FILL PIECE COMPLETES CEILING WHEN GRID SECTIONS EXTEND BEYOND SUPPORT STRUT



KEYSTONE SUPPLIED ALUMINUM CLOSURE STRIP SNAPS INTO BOTTOM OF SUPPORT STRUT TO FINISH CEILING

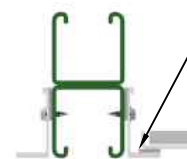

KEYSTONE SUPPLIED GASKET TO BE INSTALLED IN FIELD BY OTHERS

FIELD SUPPLIED AND INSTALLED FASTENERS MUST NOT PROTRUDE INTO THE SUPPORT STRUT AT ANY POINT WHICH WOULD INTERFERE WITH POSITIONING OF THE FIXING BLOCK (REF. VENDOR EQUIPMENT DRAWINGS)

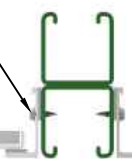

APEX CENTER TO CENTER = SUPPORT STRUT CENTER TO CENTER - 1 3/4"

CEILING LEVEL SUPPORT STRUT = 90 ft.

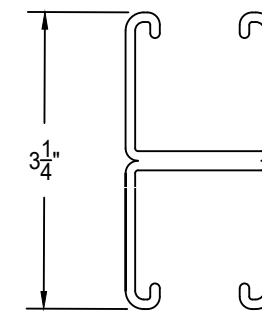

CEILING LEVEL SUPPORT STRUT HEIGHT, GC/AHJ TO COORDINATE, AND ADVISE KEYSTONE OF ANY DISCREPANCIES OR DEVIATIONS

SUPERSUITE
by PRICE

Project:

274978

Revision: B

08-01-2023

- CEILING SYSTEM SUPPORT STRUT GRID AND ALL SECONDARY SUPPORT TO STRUCTURE TO BE DESIGN, COORDINATED, PROVIDED, AND INSTALLED BY OTHERS
- CEILING LEVEL SUPPORT STRUT INTEGRATION DETAILS REPRESENT PRICE RECOMMENDATIONS AND BEST PRACTICE.
- KEYSTONE CEILING SYSTEM HAS BEEN DESIGNED TO INTEGRATE WITH CEILING LEVEL SUPPORT STRUT LAYOUT AS SHOWN. GC/AHJ TO COORDINATE, AND ADVISE KEYSTONE OF ANY DISCREPANCIES OR DEVIATIONS

SUPERSUITE

OPERATING ROOM DIFFUSER SYSTEM WITH INTEGRATED LED LIGHTING INLET MANIFOLD INSTALLATION DETAILS



CEILING LEVEL
SUPPORT STRUT
(BY OTHERS)

SECONDARY
SUPPORT STRUT
(BY OTHERS)

SUPERSUITE MODULES ARE DESIGNED
TO FIT WITHIN SUPPORT STRUCTURE

REMOVE INTERNAL COMPONENTS AND
RAISE SUPERSUITE MODULES. FASTEN
TO UNISTRUT AS SHOWN ON PAGE 10

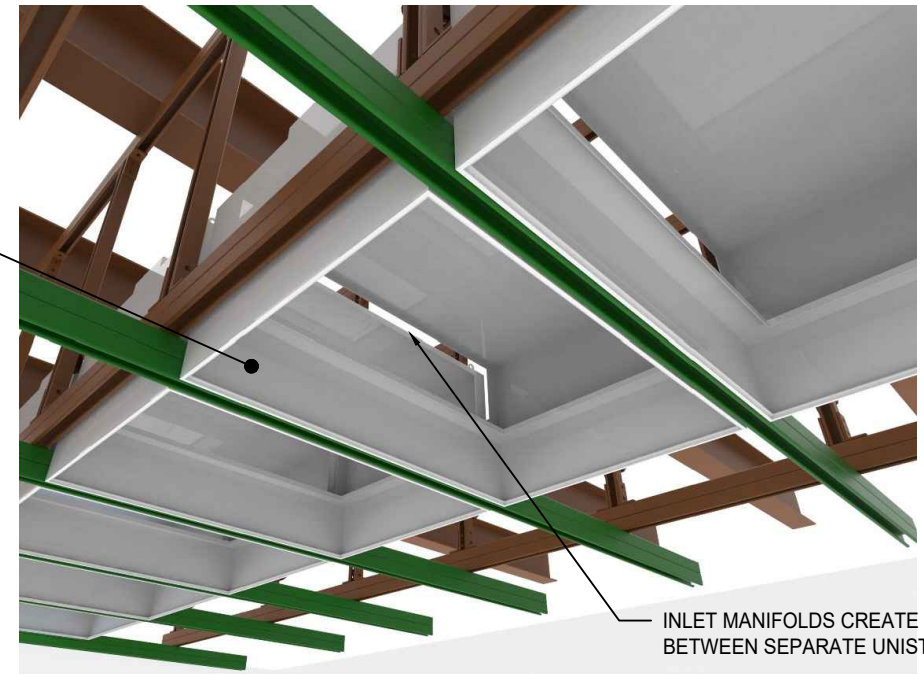

INLET MANIFOLDS CREATE COMMON PLENUM
BETWEEN SEPARATE UNISTRUT MODULES

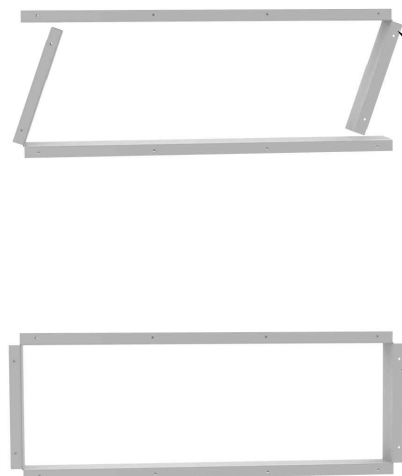

INLET MANIFOLDS SHIP AS TWO "L"
ANGLES TO BE INSTALLED FROM THE
INSIDE OF PLENUM MODULES

REDUCE 90 DEGREE ANGLE OF
"L" PIECE AND INSTALL WITH
FLANGES INSIDE EACH PLENUM

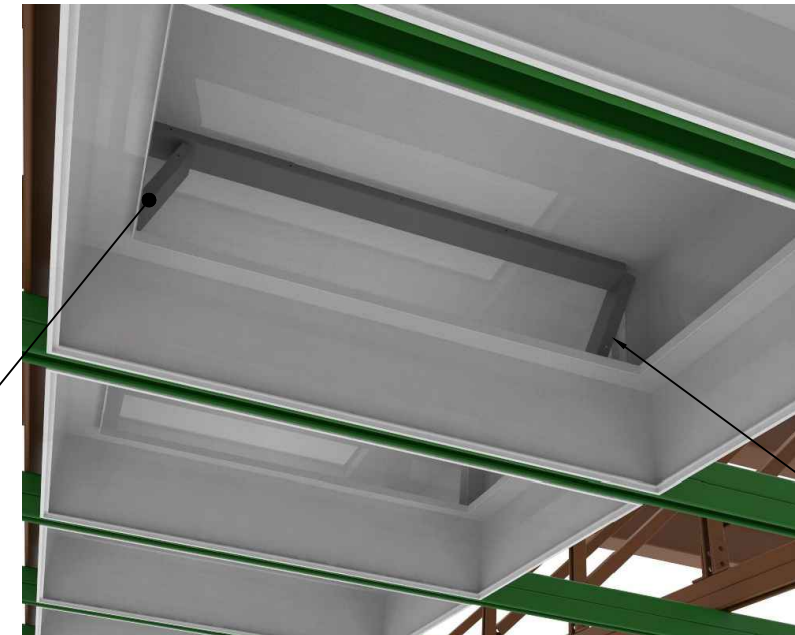

FASTEN MANIFOLDS TO SUPERSUITE
PLENUM USING PILOT HOLES WITH
SELF TAPPING SCREWS PROVIDED
BY OTHERS

- CEILING SYSTEM SUPPORT STRUT GRID AND ALL SECONDARY SUPPORT TO STRUCTURE TO BE DESIGN, COORDINATED, PROVIDED, AND INSTALLED BY OTHERS
- CEILING LEVEL SUPPORT STRUT INTEGRATION DETAILS REPRESENT PRICE RECOMMENDATIONS AND BEST PRACTICE.
- KEYSTONE CEILING SYSTEM HAS BEEN DESIGNED TO INTEGRATE WITH CEILING LEVEL SUPPORT STRUT LAYOUT AS SHOWN. GC/AHJ TO COORDINATE, AND ADVISE KEYSTONE OF ANY DISCREPANCIES OR DEVIATIONS

[CLICK HERE FOR
3D MODEL](#)

SUPERSUITE
by **PRICE**

Project:

274978

Revision: B

08-01-2023

SUPERSUITE

OPERATING ROOM DIFFUSER SYSTEM WITH INTEGRATED LED LIGHTING

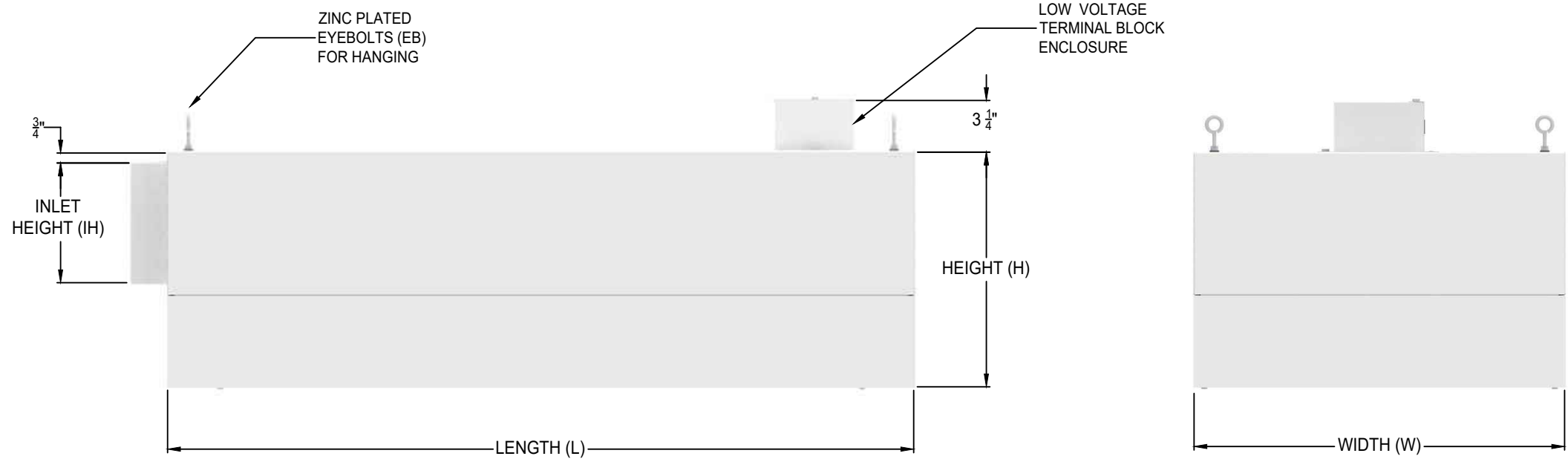

STANDARD CONSTRUCTION

- 14 GA (.064" THICK) ALUMINUM PLENUM
- EXTRUDED ALUMINUM OUTER FRAME AND DIFFUSER FACE FRAME
- TIG WELDED PLENUM, DIFFUSER FACE AND OUTER FRAME
- ZINC PLATED EYE BOLTS FOR HANGING
- OPTIONAL GALVANIZED BRACKETS FOR HANGING
- OPTIONAL SEISMIC BRACKETS AVAILABLE FOR SEISMIC CERTIFICATION PRE-APPROVAL AS PER OSP-0627-10
- ROOM-SIDE ADJUSTABLE APERTURE PLATE DAMPER
- TWO STAINLESS STEEL RETAINER CABLES PER DIFFUSER FACE
- DIFFUSER FACE SECURED WITH 1/4 TURN FASTENERS

LED LIGHTING SPECIFICATIONS

- LED LIGHTING INTEGRATED INTO EACH DIFFUSER MODULE
- IP67 RATED LED STRIP WITH QUICK CONNECTORS
- COLOR RENDERING INDEX (CRI) 95
- L80>60,000 HRS
- FOR IES PHOTOMETRIC FILES VISIT: <https://keystonecleanair.com/supersuite/>

FINISH

- B12 WHITE
- OPTIONAL AMB12 ANTI-MICROBIAL WHITE

LED COLOR TEMPERATURE

- 5000K (W935)
- OPTIONAL 4000K (W930)

LISTINGS

- **UL 1598/CSA C22.2 #250.0** - AIR-HANDLING LUMINAIRES
- **UL 2043** - FIRE TEST FOR HEAT AND VISIBLE SMOKE RELEASE FOR DISCRETE PRODUCTS AND THEIR ACCESSORIES INSTALLED IN AIR-HANDLING SPACES
- **UL 2108/CSA 22.2#250.0** - LOW VOLTAGE LIGHTING SYSTEM
- **UL 8750/CSA-C22.2 #250.13** - LIGHT EMITTING DIODE (LED) EQUIPMENT FOR USE IN LIGHTING PRODUCTS
- **UL 1310/CSA C22.2 #223-M91** - CLASS 2 POWER UNITS
- **UL 94** - FLAMMABILITY OF PLASTIC MATERIALS FOR PARTS IN DEVICES AND APPLIANCES
- **IP 67** - RATED INGRESS PROTECTION AGAINST DUST AND LIQUIDS
- **MIL-STD-461** - ELECTROMAGNETIC COMPATIBILITY
- **OSP-0627-10** - SEISMIC PRE-APPROVAL

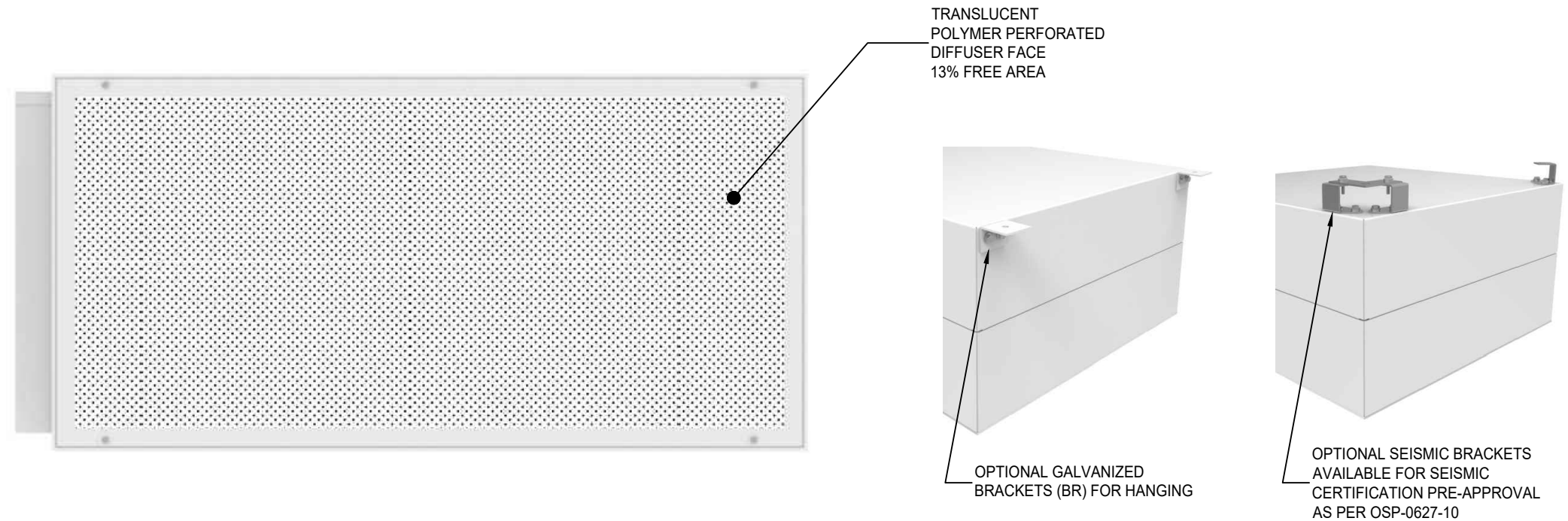

STANDARD MODULE SIZING CHART					
NOMINAL (W)	NOMINAL (L)	ACTUAL (W)	ACTUAL (L)	HEIGHT (H)	
				MIN	MAX
24.000	24.000	24.250	24.250	10	20
24.000	34.000	24.250	34.000	10	20

- STANDARD HEIGHT (H) = 15"
- MINIMUM HEIGHT WITH HEPA FILTER = 12"
- MINIMUM WIDTH WITH HEPA FILTER = 12"
- MAX INLET HEIGHT (IH) = HEIGHT (H) - 7"
- MAX INLET HEIGHT (IH) WITH HEPA = HEIGHT (H) - 8"

KEYSTONE CEILING SYSTEM WEIGHTS		
KEYSTONE SUPPLIED COMPONENTS	TOTAL SQUARE FEET =265 SQ.FT.	789 lbs.
SSA	98 SQ.FT.	686 lbs.
APEX	91 SQ.FT.	46 lbs.
PANELS	76 SQ.FT.	57 lbs.

SUPERSUITE by PRICE		
Project:		
274978	Revision: B	08-01-2023

SUPERSUITE

OPERATING ROOM DIFFUSER SYSTEM WITH INTEGRATED LED LIGHTING FACE ACCESS APERTURE PLATE DAMPER DETAILS ○ OPTIONAL ROOMSIDE HEPA FILTRATION

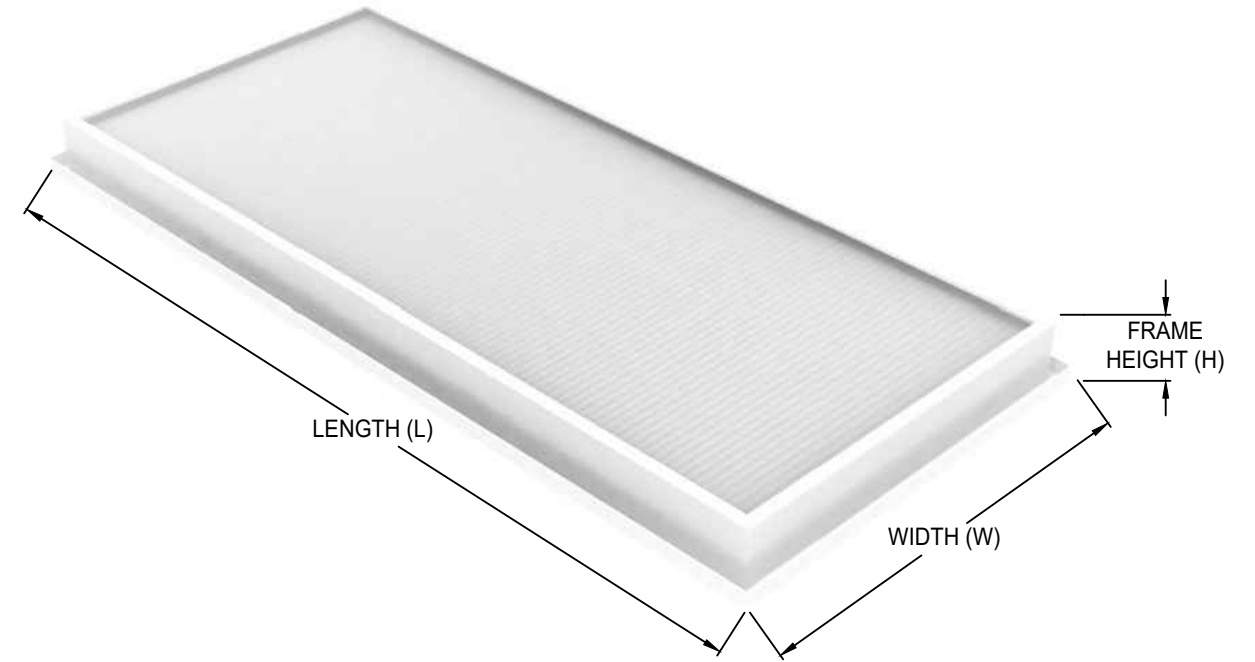
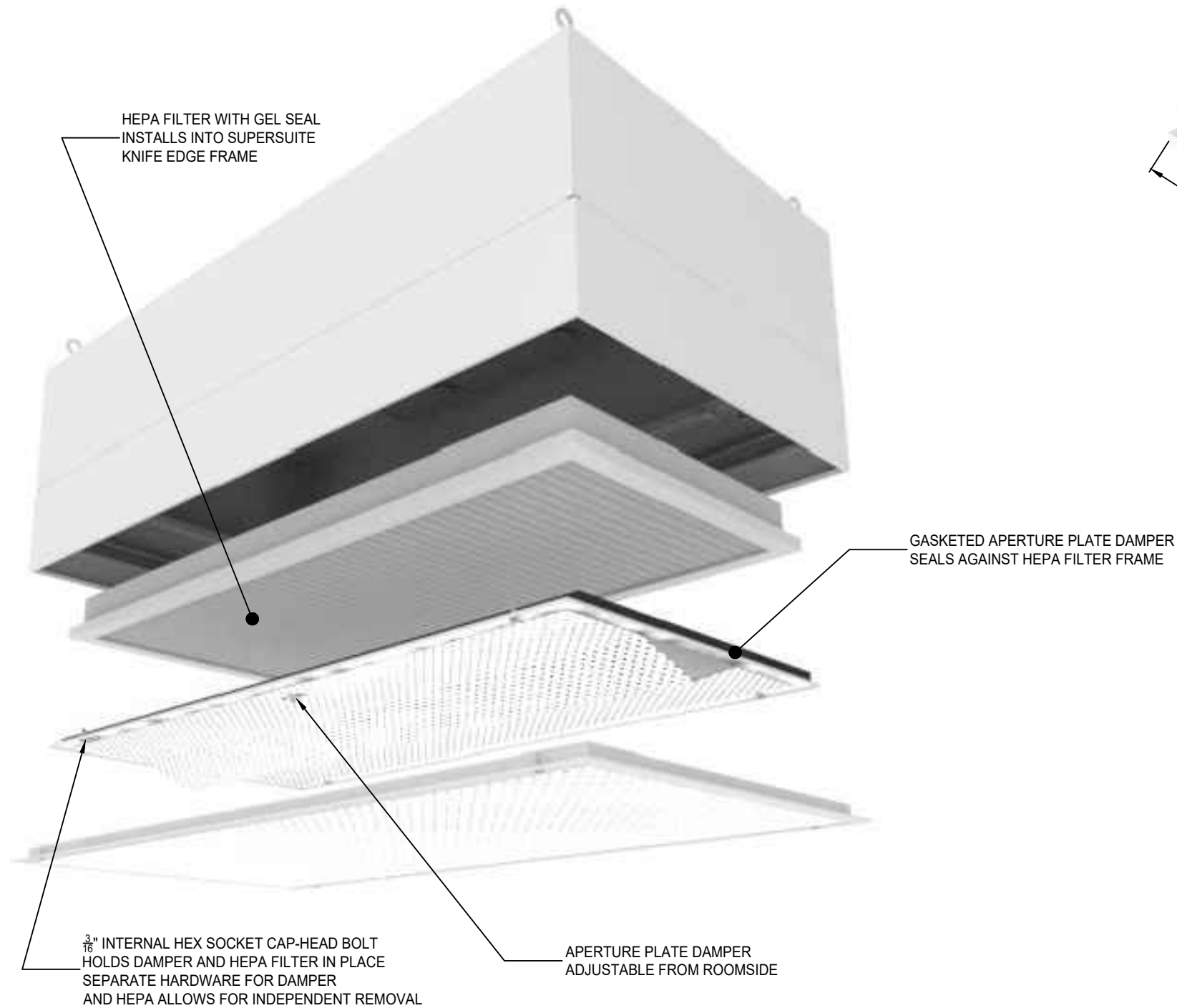

STANDARD FILTER SIZING CHART				
REPLACEMENT PART #	NOMINAL (W)	NOMINAL (L)	ACTUAL (W)	ACTUAL (L)
042299-029	24	24	19.88	19.88
SPECIAL	24	35	19.88	30.63

NOTES:

- FILTER PLEATS RUN PARALLEL TO THE WIDTH (W) DIMENSION
- DIMENSIONS W & L TOLERANCES $\pm \frac{1}{16}$
- FILTERS COME WITH GEL SEAL FILLED CHANNEL
- FILTERS MUST BE ORDERED SEPARATELY UNDER THE VANGUARD-1-X LINESTRING

FRAME DETAILS:

- MATERIAL: ANODIZED EXTRUDED ALUMINUM
- THICKNESS: $\frac{1}{16}$ " (MINIMUM)
- FILTERS ARE UL 900 CLASS 1 CERTIFIED
- EFFICIENCY AND LEAK SCAN TESTED
- HEPA EFFICIENCY: 99.99% (.3 MICRON)
- MINIMUM MODULE WIDTH FOR ROOMSIDE HEPA FILTRATION IS 12"

SUPERSUITE
by **PRICE**

Project:

274978

Revision: B

08-01-2023

VISIT KEYSTONE WEBSITE FOR FILTER QUICK START GUIDE

<https://keystonecleanair.com/home/products/>

NOTE:

UL 1598 DOES NOT HAVE PROVISIONS FOR HEPA FILTERS MOUNTED WITHIN FIXTURE. SSA COMPLIES WITH UL 1598 WITH HEPA FILTERS ORDERED SEPERATELY ON VANGUARD-1-X LINESTRING.

SUPERSUITE

OPERATING ROOM DIFFUSER SYSTEM WITH INTEGRATED LED LIGHTING FACE ACCESS APERTURE PLATE DAMPER DETAILS ○ OPTIONAL ROOMSIDE HEPA FILTRATION

FILTER HOLD DOWN TAB DETAIL

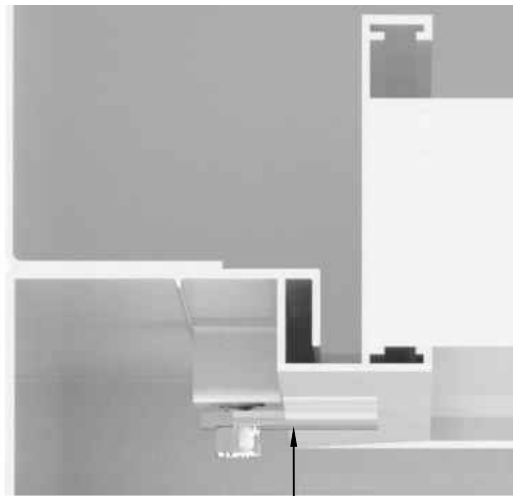

OPTIONAL
FILTER HOLD
DOWN TAB

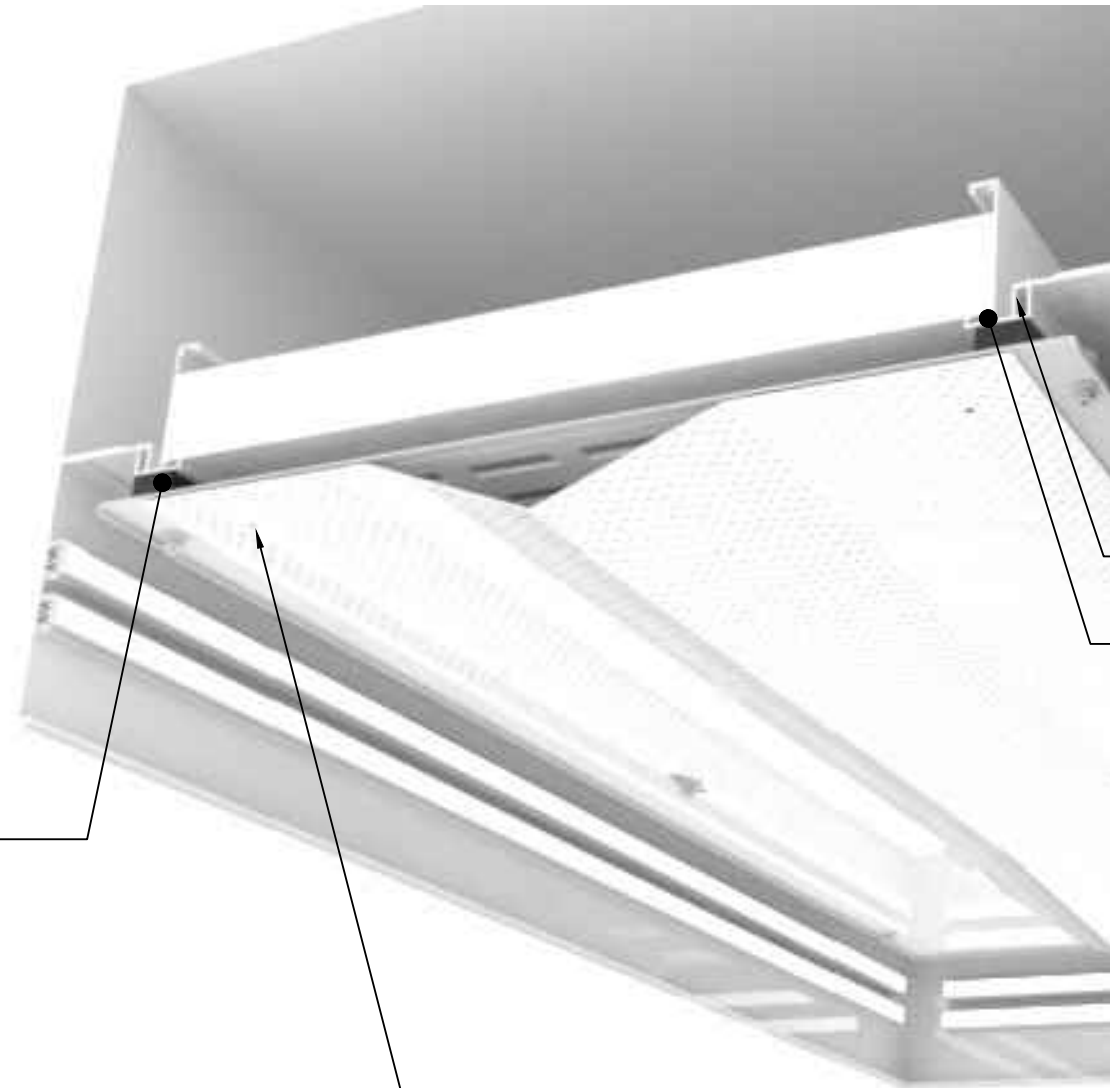

APERTURE PLATE
DAMPER WITH UL2043
RATED GASKET
SEALS AGAINST
THE KNIFE EDGE

DAMPER SECURED
IN PLACE WITH SCREWS
INSTALL BY USING $\frac{3}{16}$ " ALLEN KEY

KNIFE EDGE
HEPA FILTER
GEL SEAL

STATIC PRESSURE PORT DETAIL

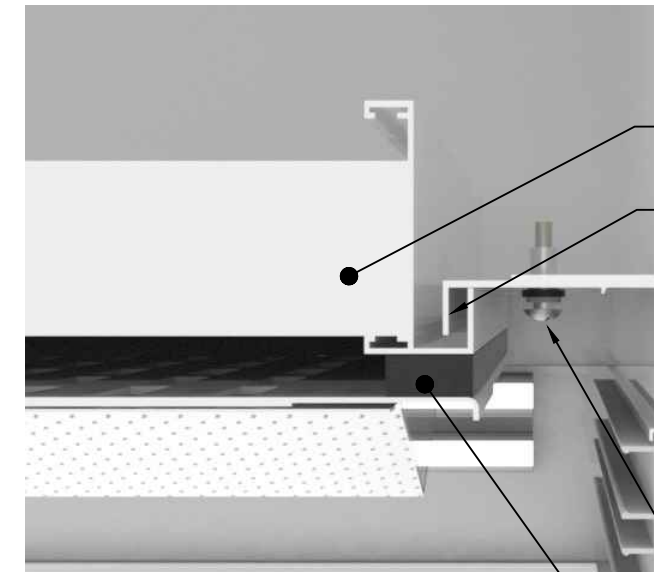

OPTIONAL
HEPA FILTER

KNIFE EDGE

STATIC
PRESSURE
PORT

APERTURE PLATE
DAMPER WITH UL2043
RATED GASKET
SEALS AGAINST
THE HEPA FRAME

SUPERSUITE
by **PRICE**

Project:

274978

Revision: B

08-01-2023

SUPERSUITE

OPERATING ROOM DIFFUSER SYSTEM WITH INTEGRATED LED LIGHTING SRDC SUPER REMOTE DRIVER CABINETS - STANDARD OFFERINGS

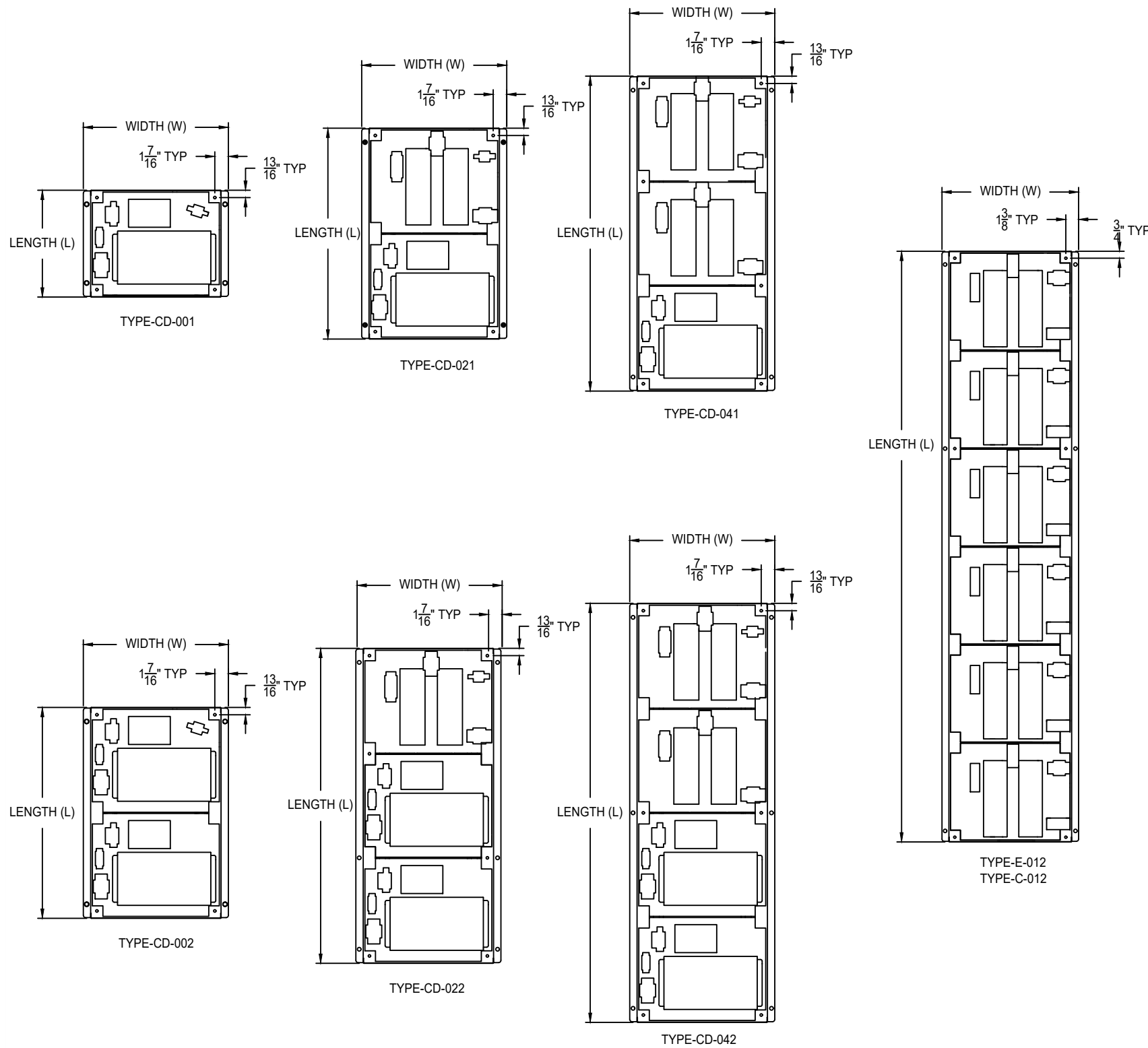

- ALL DRIVER CABINETS ARE ORDERED ON SRDC-1-X LINESTRING.
- REMOTE DRIVER CABINETS REQUIRE SINGLE POINT HIGH VOLTAGE (120-277V~) CONNECTION (277V~ RECOMMENDED).
- ALL DIMMING SWITCHES ARE ORDERED ON SCA-1-X LINESTRING.
- 0-10V DIMMING SWITCH SHIPPED LOOSE. THE TOTAL LENGTH FOR 0-10V CONTROL SIGNAL WIRING FOR THIS CONTROL SHOULD NOT EXCEED 500'. DO NOT USE WIRE SMALLER THAN 20 AWG.
- 8A AND 16A 0-10V DIMMING SWITCHES AVAILABLE. DIMMING ZONES AND CONTROL ARE COMPLETELY CUSTOMIZABLE.
- 0-10V DIMMING SIGNAL FROM SWITCH CAN CONTROL UP TO 100 DRIVERS.
- LED DRIVER TYPE E OFFERS CONTINUOUS, FLICKER-FREE DIMMING FROM 100% TO 1% WITH 0-10 VOLTAGE DIMMER SHIPPED LOOSE OR DIMMING SIGNAL PROVIDED BY OTHERS.
- LED DRIVER TYPE C AND CD OFFERS CONTINUOUS, FLICKER-FREE DIMMING FROM 100% TO 10% WITH 0-10 VOLTAGE DIMMER SHIPPED LOOSE. OPTIONAL SOLID STATE RELAY WITH 4-32VDC RELAY SHUT OFF SIGNAL AND 0-10VDC DIMMING SIGNAL PROVIDED BY OTHERS
- 30A DISCONNECT SWITCH AVAILABLE TO PROVIDE FULL SYSTEM SHUTOFF WHEN UTILIZING 0-10V SIGNAL
- LED DRIVERS SHIP FACTORY WIRED AND INSTALLED IN REMOTE DRIVER CABINETS.
- SRDC DRIVER CABINETS CAN BE WALL MOUNTED, TYPICALLY IN AN ADJACENT EQUIPMENT ROOM, OR INSTALLED ABOVE THE CEILING. DRIVER CABINETS CANNOT BE RECESSED BETWEEN WALL STUDS AS THEY REQUIRE VENTILATION.
- SUPERSUITE MODULES COME WITH FACTORY WIRED AND INSTALLED TOP MOUNTED LOW VOLTAGE TERMINAL BLOCK ENCLOSURE
- INCOMING HIGH VOLTAGE POWER AND LOW VOLTAGE CONNECTION BETWEEN SUPERSUITE MODULES AND REMOTE DRIVER CABINET ARE THE RESPONSIBILITY OF THE INSTALLER.
- MAX DISTANCE BETWEEN SUPERSUITE MODULE AND REMOTE DRIVER CABINET IS DEPENDANT ON WIRE GAUGE TO MINIMIZE VOLTAGE DROP. SEE TABLE BELOW.
- SEE SUPERSUITE INSTALLATION MANUAL AVAILABLE AT <https://keystonecleanair.com/supersuite/>
- FOR RECOMMENDED REMOTE DRIVER CABINET AND SUPERSUITE SYSTEM INSTALLATION.

DRIVER CABINET	# OF MODULES	# OF DRIVERS	L	W	H	WEIGHT	AC CURRENT - TYPE E (120VAC / 277VAC)	AC CURRENT - TYPE C (120VAC / 277VAC)
TYPE E/C-001	1	1	0'-11 1/2"	1' - 3 1/2"	5"	7 lbs.	0.95A / 0.4A	1.2A / 0.50A
TYPE E/C-002		2	0'-11 1/2"	1' - 3 1/2"	5"	15 lbs.	1.9A / 0.8A	2.4A / 1.7A
TYPE E/C-003	2	3	1' - 10 9/16"	1' - 3 1/2"	5"	22 lbs.	2.95A / 1.2A	3.6A / 2.9A
TYPE E/C-004		4	1' - 10 9/16"	1' - 3 1/2"	5"	30 lbs.	3.8A / 1.6A	4.8A / 4.1A
TYPE E/C-005	3	5	2' - 9 11/16"	1' - 3 1/2"	5"	37 lbs.	4.75A / 2A	6.0A / 5.3A
TYPE E/C-006		6	2' - 9 11/16"	1' - 3 1/2"	5"	45 lbs.	5.7A / 2.4A	7.2A / 6.5A
TYPE E/C-007	4	7	3' - 8 13/16"	1' - 3 1/2"	5"	52 lbs.	6.65A / 2.8A	8.4A / 7.7A
TYPE E/C-008		8	3' - 8 13/16"	1' - 3 1/2"	5"	60 lbs.	7.6A / 3.2A	9.6A / 8.9A
TYPE E/C-009	5	9	4' - 7 15/16"	1' - 3 1/2"	5"	67 lbs.	8.55A / 3.6A	10.8A / 10.1A
TYPE E/C-010		10	4' - 7 15/16"	1' - 3 1/2"	5"	75 lbs.	9.5A / 4A	12.0A / 11.3A
TYPE E/C-011	6	11	5' - 7 1/16"	1' - 3 1/2"	5"	82 lbs.	10.45A / 4.4A	13.2A / 12.5A
TYPE E/C-012		12	5' - 7 1/16"	1' - 3 1/2"	5"	90 lbs.	11.4A / 4.8A	14.4A / 13.7A

DRIVER CABINET	# OF MODULES	# OF DRIVERS	L	W	H	WEIGHT	AC CURRENT - TYPE E (120VAC / 277VAC)
TYPE-CD-001	3	1	0'-11 1/2"	1' - 3 1/2"	5"	20 lbs.	7A / 2.9A
TYPE-CD-021	4	3	1' - 10 9/16"	1' - 3 1/2"	5"	35 lbs.	9.4A / 3.9A
TYPE-CD-041	5	5	2' - 9 11/16"	1' - 3 1/2"	5"	50 lbs.	11.8A / 4.9A
TYPE-CD-002	6	2	1' - 10 9/16"	1' - 3 1/2"	5"	40 lbs.	14.0A / 5.8A
TYPE-CD-022	7	4	2' - 9 11/16"	1' - 3 1/2"	5"	55 lbs.	- / 6.8A
TYPE-CD-042	8	6	3' - 8 13/16"	1' - 3 1/2"	5"	70 lbs.	- / 7.8A

- TYPE C & CD OFFERS 100 TO 10% DIMMING
- TYPE E OFFERS 100 TO 1% DIMMING
- TYPE CD OFFERS OVER 40% SPACE SAVING FOR CABINET INSTALLATION
- TYPE C ALLOWS FOR RECESSED TYPE IC INSTALLATION
- TYPE E & CD ALLOWS FOR SURFACE, WALL OR CEILING MOUNT INSTALLATION. PASSIVE VENTILATION OF CABINET IS REQUIRED THROUGH OUTER BOX LOUVERS

SUPERSUITE
by **PRICE**

Project:

274978

Revision: B

08-01-2023

SUPERSUITE

OPERATING ROOM DIFFUSER SYSTEM WITH INTEGRATED LED LIGHTING

- SRDC SUPER REMOTE DRIVER CABINETS - WIRING FOR SINGLE DIMMING ZONE (100 TO 1% DIMMING) PRECISION DIMMING OPTION

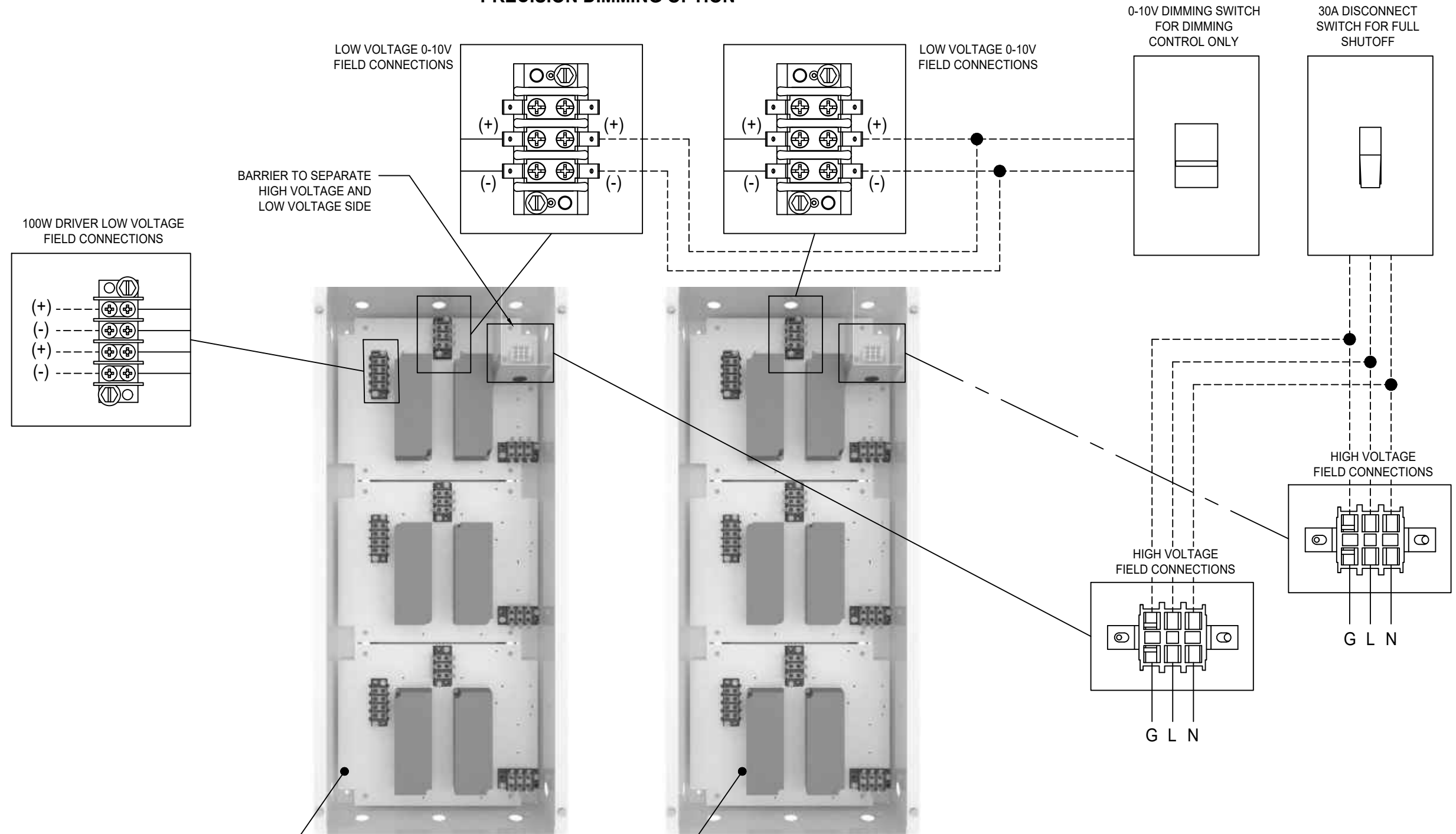

ALL INTERNAL REMOTE DRIVER CABINET WIRING IS DONE IN THE FACTORY

SRDC-2-X REMOTE DRIVER CABINET TYPE CD SHOWN

ALL INTERNAL REMOTE DRIVER CABINET WIRING IS DONE IN THE FACTORY

SRDC-2-X REMOTE DRIVER CABINET TYPE CD SHOWN

- PRE-WIRED FACTORY CONNECTION
- - - FIELD CONNECTION
- G GROUND
- N NEUTRAL
- L LINE CONNECTION

SUPERSUITE
by **PRICE**

Project:		
274978	Revision: B	08-01-2023

• VISUAL WIRING DETAIL IS SHOWN FOR REFERENCE ONLY, REFERENCE INSTALLATION MANUAL FOR WIRING DIAGRAMS
 • INSTALLATION WORK AND ELECTRICAL WIRING MUST BE COMPLETED BY A CERTIFIED ELECTRICIAN AND/OR QUALIFIED PERSON(S) IN ACCORDANCE WITH APPLICABLE ELECTRICAL CODES AND STANDARDS

SUPERSUITE

OPERATING ROOM DIFFUSER SYSTEM WITH INTEGRATED LED LIGHTING

- SRDC SUPER REMOTE DRIVER CABINETS - OPTIONAL WIRING FOR INGLE DIMMING ZONE (100 TO 10% DIMMING)
COMPACT / SPACING SAVINGS OPTION

100W DRIVER LOW VOLTAGE FIELD CONNECTIONS

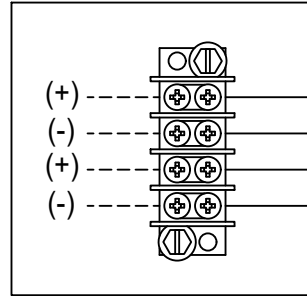

LOW VOLTAGE 0-10V FIELD CONNECTIONS

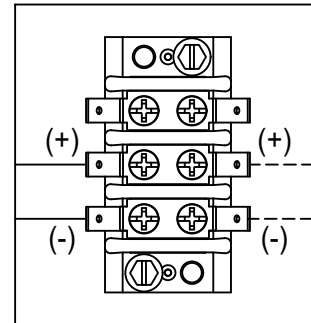

LOW VOLTAGE 0-10V FIELD CONNECTIONS

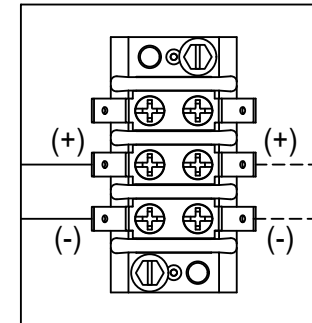

0-10V DIMMING SWITCH FOR DIMMING CONTROL ONLY

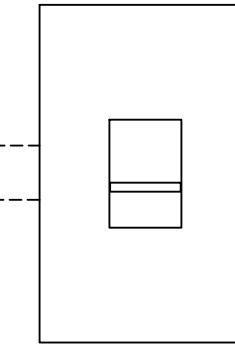

30A DISCONNECT SWITCH FOR FULL SHUTOFF

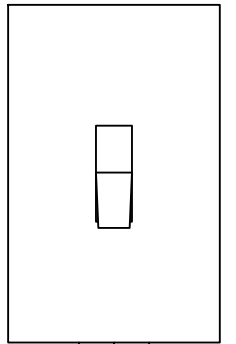

BARRIER TO SEPARATE HIGH VOLTAGE AND LOW VOLTAGE SIDE

600W DRIVER POSITIVE LOW VOLTAGE FIELD CONNECTIONS

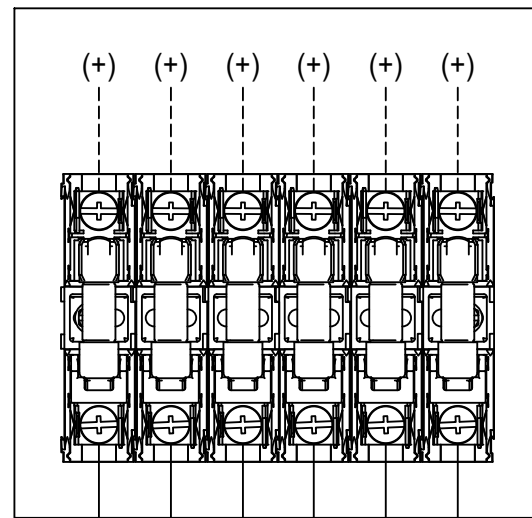

600W DRIVER NEGATIVE LOW VOLTAGE FIELD CONNECTIONS

(-) (-) (-) (-) (-) (-)

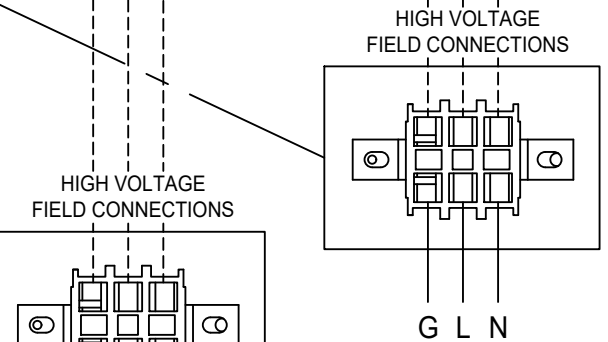
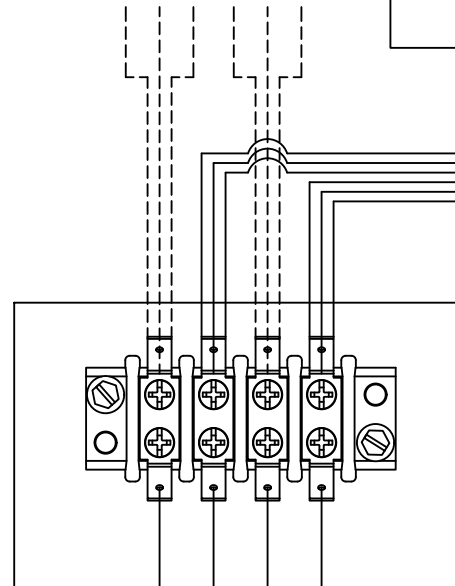

HIGH VOLTAGE FIELD CONNECTIONS

G L N

CLASS CC FAST ACTING 4A FUSE BLOCK LIMITS CURRENT TO MAINTAIN CLASS 2 SIGNAL TO LUMINAIRE

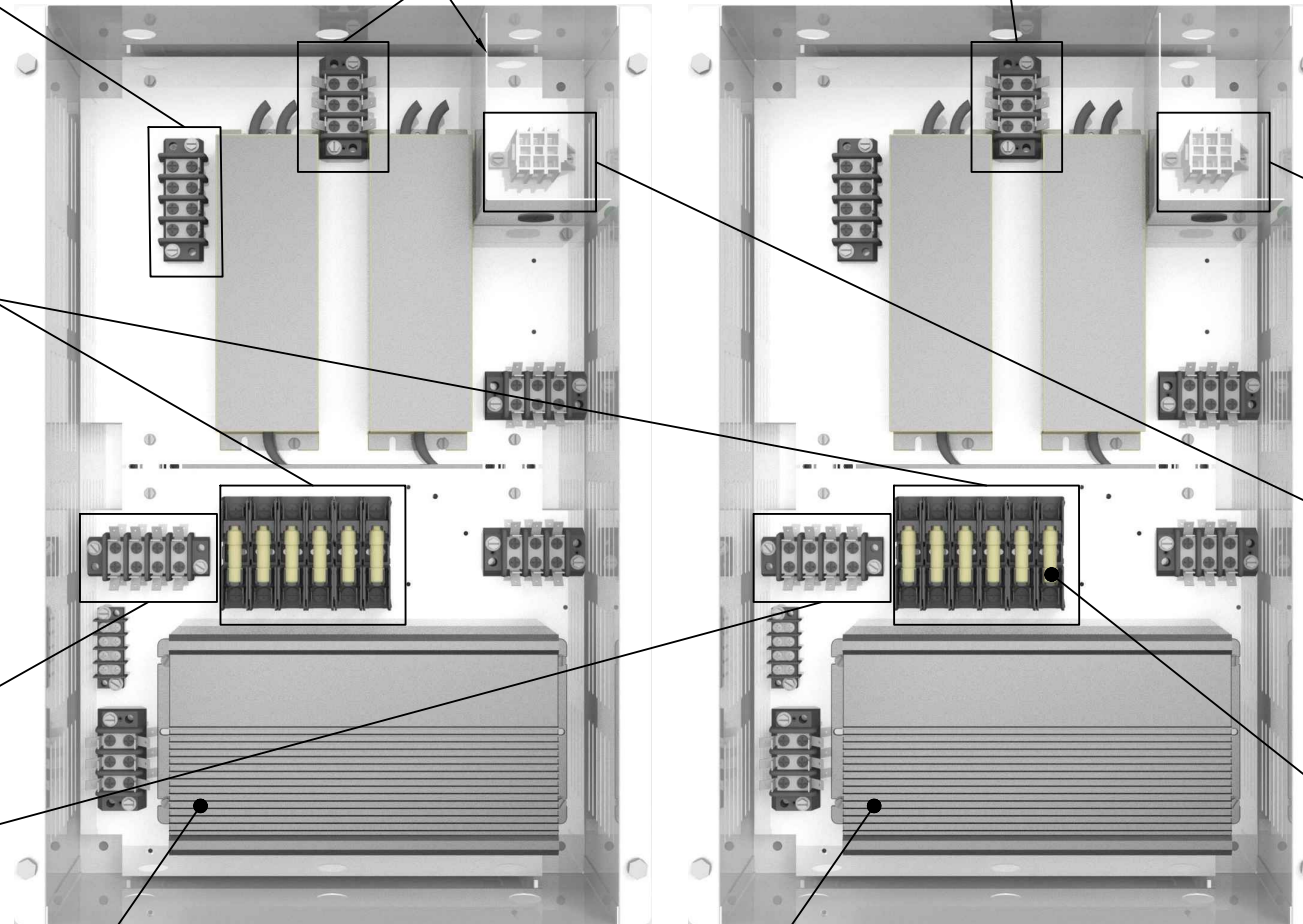

SRDC-2-X REMOTE DRIVER CABINET TYPE CD SHOWN

SRDC-2-X REMOTE DRIVER CABINET TYPE CD SHOWN

ALL INTERNAL REMOTE DRIVER CABINET WIRING IS DONE IN THE FACTORY

ALL INTERNAL REMOTE DRIVER CABINET WIRING IS DONE IN THE FACTORY

- PRE-WIRED FACTORY CONNECTION
- - - FIELD CONNECTION
- G GROUND
- N NEUTRAL
- L LINE CONNECTION

SUPERSUITE
by **PRICE**

Project:

274978

Revision: B

08-01-2023

• VISUAL WIRING DETAIL IS SHOWN FOR REFERENCE ONLY, REFERENCE INSTALLATION MANUAL FOR WIRING DIAGRAMS
• INSTALLATION WORK AND ELECTRICAL WIRING MUST BE COMPLETED BY A CERTIFIED ELECTRICIAN AND/OR QUALIFIED PERSON(S) IN ACCORDANCE WITH APPLICABLE ELECTRICAL CODES AND STANDARDS

SUPERSUITE

OPERATING ROOM DIFFUSER SYSTEM WITH INTEGRATED LED LIGHTING APEX INTEGRATION DETAILS

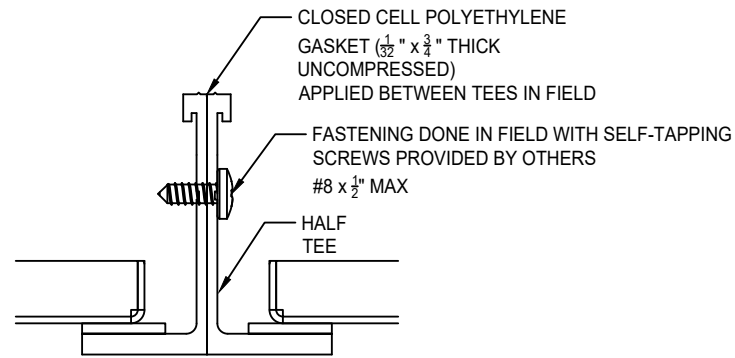

A HALF TEE FIELD JOINT

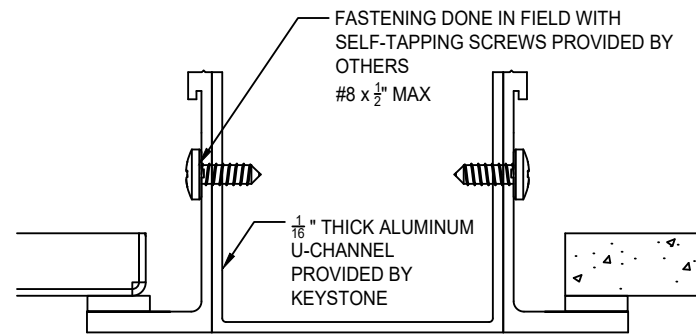

C U CHANNEL DETAIL

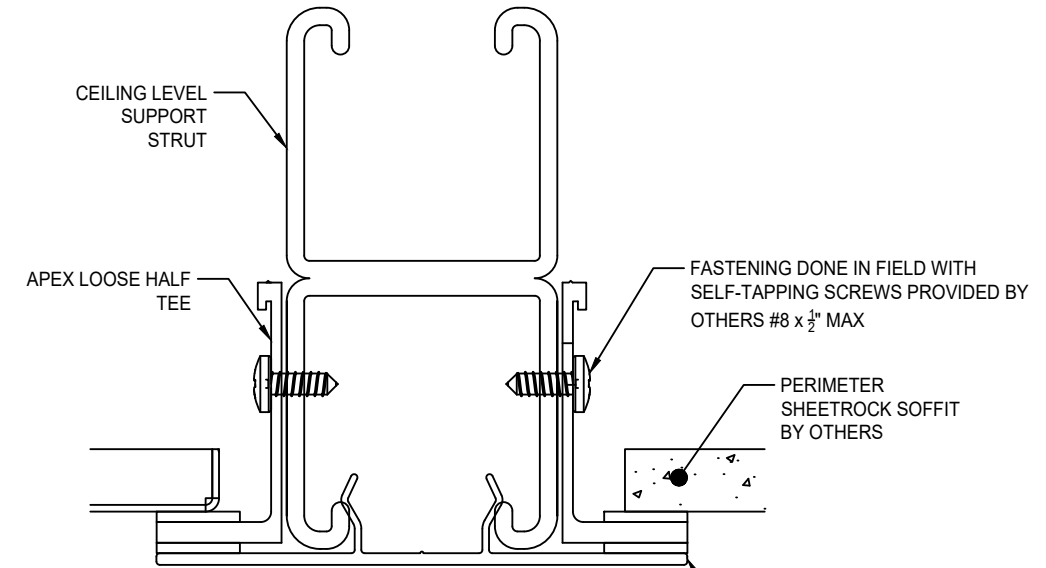

B LOOSE HALF TEE PERIMETER SHEETROCK SOFFIT DETAIL

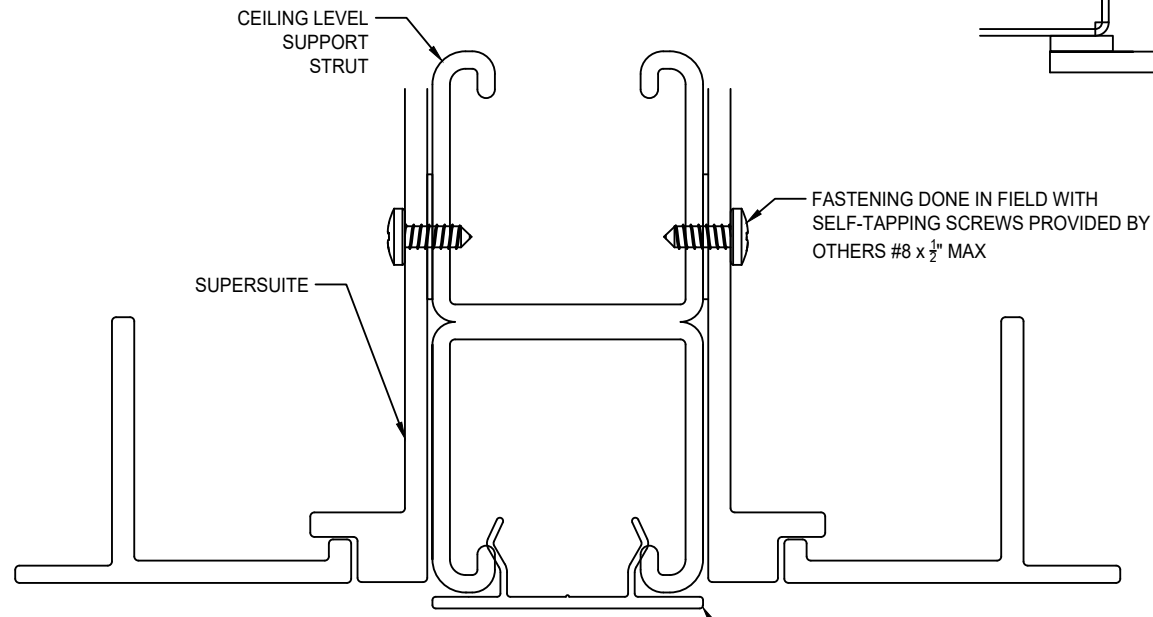

D SSA UNISTRUT INTEGRATION

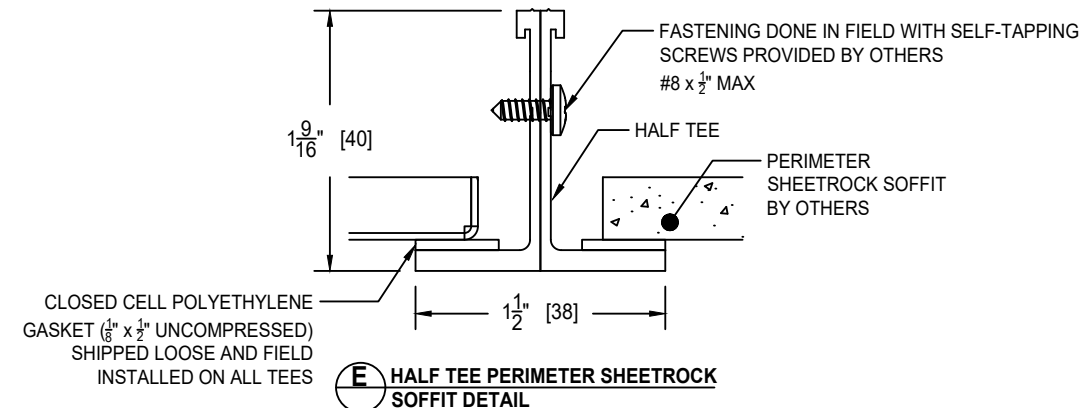

E HALF TEE PERIMETER SHEETROCK SOFFIT DETAIL

SUPERSUITE
by price

Project:

274978

Revision: B

08-01-2023

SUPERSUITE

OPERATING ROOM DIFFUSER SYSTEM WITH INTEGRATED LED LIGHTING

SC - SOLID CORE

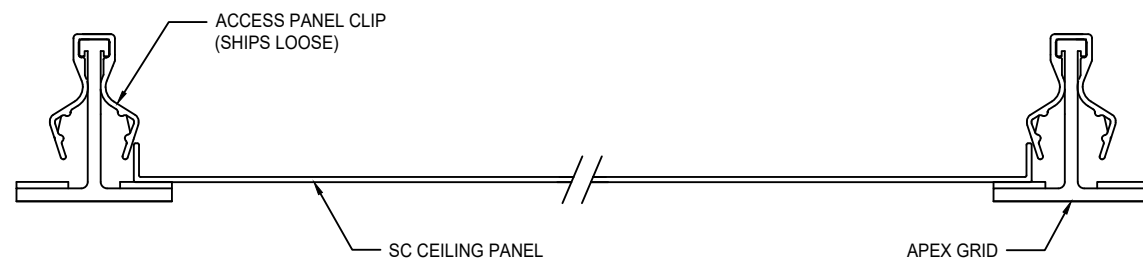
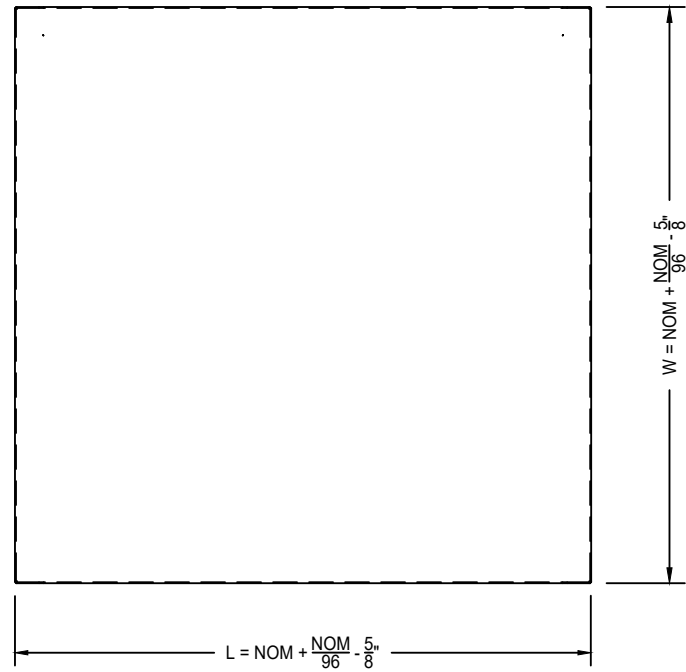

SCF - SOLID CORE WITH FLUSH MOUNT FRAME

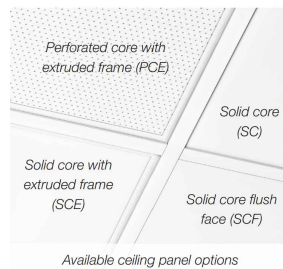
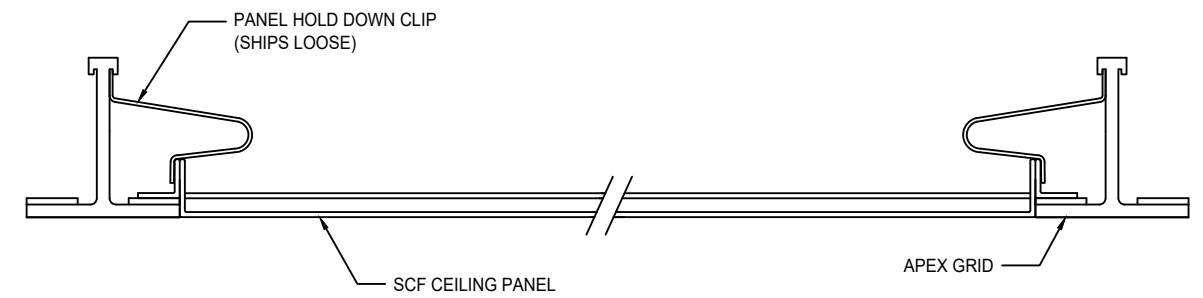
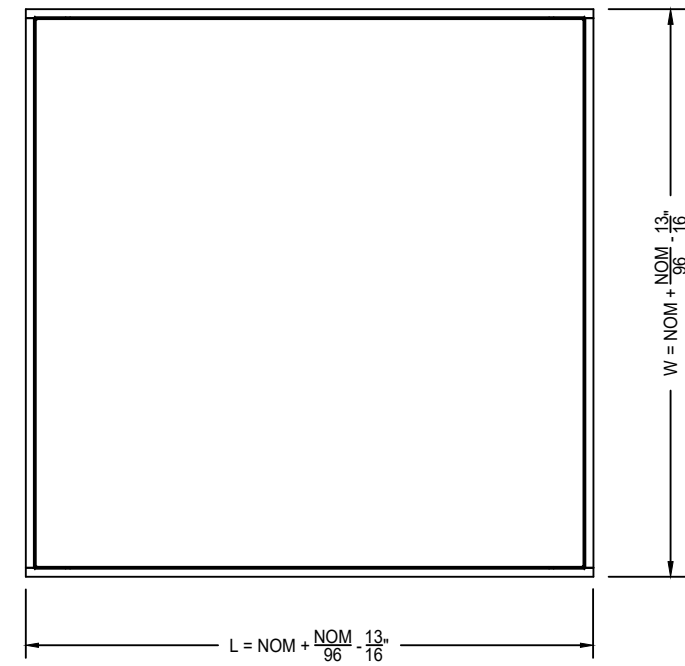

PANEL MATERIAL / FINISH:

- SC PANEL - .080" ALUMINUM / B12 STANDARD WHITE
- SCF PANEL - .040" ALUMINUM / B12 STANDARD WHITE

CEILING TYPE:

- APEX - 1 1/2" HOSPITAL GRADE WELDED CEILING SYSTEM

SUPERSUITE
by **PRICE**

Project:

274978

Revision: B

08-01-2023

SUPERSUITE

OPERATING ROOM DIFFUSER SYSTEM WITH INTEGRATED LED LIGHTING SUPPORTING CONTENT

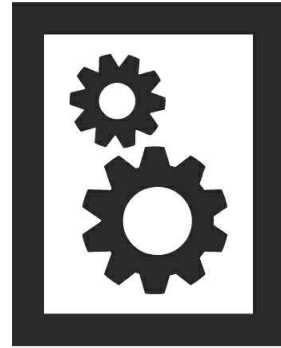

MANUALS

SSA SUPERSUITE MANUAL
VANGUARD ROOM-SIDE REPLACEABLE FILTER (RSR) QUICK START GUIDE
SRDC SUPER DRIVER CABINET MANUAL
SCA SUPER COMPONENTS AND ACCESSORIES MANUAL
APEX WELDED CEILING SYSTEM WITH INTEGRATED UNISTRUT SYSTEM MANUAL



SUBMITTALS

VANGUARD REPLACEMENT FILTER SUBMITTAL
APEX WELDED CEILING SYSTEM SUBMITTAL



CATALOG / PERFORMANCE

SSA SUPERSUITE CATALOG
SSA SUPERSUITE PERFORMANCE

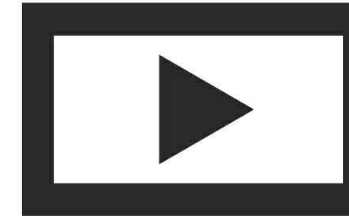

VIDEOS

SSA SUPERSUITE LAUNCH VIDEO
SSA SUPERSUITE INSTALLATION TIME LAPSE VIDEO
SSA SUPERSUITE SMOKE TEST VIDEO

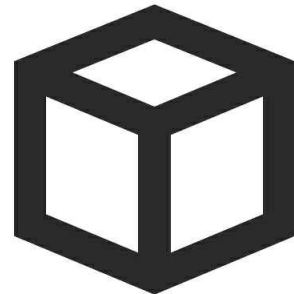

REVIT FILES

SSA HYBRID OR/IMAGING SUITE REVIT FILE

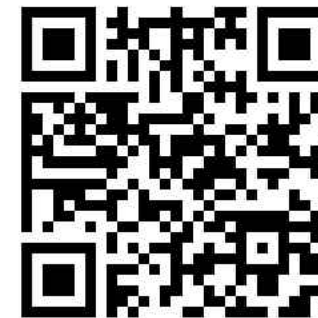

FOR MORE INFORMATION ON KEYSTONE SUPERSUITE SYSTEMS, VISIT
KEYSTONECLEANAIR.COM

SUPERSUITE
by **PRICE**

Project:

274978

Revision: B

08-01-2023